

OLYMPUS®

DIGITAL VOICE RECORDER

WS-813

WS-812

WS-811

DETAILED INSTRUCTIONS

Thank you for purchasing an Olympus
Digital Voice Recorder.

Please read these instructions for information
about using the product correctly and safely.
Keep the instructions handy for future reference.

To ensure successful recording, we recommend that
you test the record function and volume before use.



EN

Introduction

- The contents of this document are subject to change without notice. Contact our Customer Support Center for the latest information relating to product names and model numbers.
- Illustrations of the screen and the recorder shown in this manual may differ from the actual product. The utmost care has been taken to ensure the integrity of this document but should you happen to find a questionable item, error or omission, please contact our Customer Support Center.
- Olympus does not accept any liability for passive damages or damage of any kind incurred due to data loss resulting from a defect of the product, repair performed by a third party other than Olympus or an Olympus authorized service station, or for any other reason.

Trademarks and registered trademarks

- IBM and PC/AT are trademarks or registered trademarks of International Business Machines Corporation.
- Microsoft, Windows and Windows Media are registered trademarks of Microsoft Corporation.
- Macintosh and iTunes are trademarks of Apple Inc.
- microSD and microSDHC are trademarks of SD Card Association.
- MPEG Layer-3 audio coding technology is licensed from Fraunhofer IIS and Thomson.
- The product was developed based on noise-canceling technology under license from NEC Corporation.
- Voice Activity Detection technology is licensed from NTT Electronics Corporation.

Other product and brand names mentioned herein are the trademarks or registered trademarks of their respective owners.



Table of contents

Introduction

Safety precautions	4
--------------------------	---

1 Getting started

Main features	8
---------------------	---

Identification of parts	10
-------------------------------	----

Display (LCD panel)	11
---------------------------	----

Power supply	14
--------------------	----

Inserting the battery	14
-----------------------------	----

Battery settings	15
------------------------	----

Charging by connecting to a computer via USB	16
--	----

Connecting the USB-type AC adapter	17
--	----

(optional) to charge	17
----------------------------	----

Turning on/off the power	19
--------------------------------	----

HOLD	20
------------	----

Setting the time and date [Time & Date]	21
---	----

Changing the time and date	22
----------------------------------	----

Inserting and ejecting a microSD card	23
---	----

Inserting a microSD card	23
--------------------------------	----

Ejecting a microSD card	24
-------------------------------	----

[Home] display operations	25
---------------------------------	----

Notes on the folders	26
----------------------------	----

About the folders for voice recordings	26
--	----

About the folders for music playback	27
--	----

Selecting folders and files	28
-----------------------------------	----

2 About recording

Recording	29
-----------------	----

Changing the recording scene [Rec Scene]	32
--	----

Recommended settings according to	33
---	----

the recording conditions	33
--------------------------------	----

Recording from an external microphone or	34
--	----

other device	34
--------------------	----

3 About playback

Playback	36
----------------	----

Searching for a file	40
----------------------------	----

Changing the playback sound	41
-----------------------------------	----

Setting an index mark or a temp mark	42
--	----

How to begin segment repeat playback	43
--	----

Changing the playback scene [Play Scene]	44
--	----

Erasing	45
---------------	----

Erasing files	45
---------------------	----

Erasing a folder	45
------------------------	----

4 About the FM radio (WS-813 only)

Using the FM radio	47
--------------------------	----

FM radio mode operations	48
--------------------------------	----

Presetting radio stations automatically	49
---	----

[Auto-preset]	49
---------------------	----

Changing the reception mode	50
-----------------------------------	----

Adding a radio station	51
------------------------------	----

Recording from the FM radio	52
-----------------------------------	----

5 Menu setting

Menu setting method	53
---------------------------	----

File Menu	55
-----------------	----

Rec Menu	56
----------------	----

Play Menu	61
-----------------	----

LCD/Sound Menu	64
----------------------	----

Device Menu	65
-------------------	----

FM Menu	67
---------------	----

Extract voice portions from file [Voice Detect]	68
---	----

Rearranging files [Replace]	69
-----------------------------------	----

Moving/Copying files [Move/Copy]	70
--	----

Dividing files [File Divide]	72
------------------------------------	----

Changing the USB class [USB Settings]	73
---	----

Formatting the recorder [Format]	74
--	----

6 Using the recorder on your PC

Operating environment	77
-----------------------------	----

Connecting to your PC	79
-----------------------------	----

Disconnecting from your PC	80
----------------------------------	----

Transfer voice files to your PC	81
---------------------------------------	----

Usage as external memory of the PC	82
--	----

7 Other information

Alarm message list	83
--------------------------	----

Troubleshooting	85
-----------------------	----

Accessories (optional)	88
------------------------------	----

Specifications	89
----------------------	----

Technical assistance and support	94
--	----

1

2

3

4

5

6

7

Safety precautions

Before using your new recorder, read this manual carefully to ensure that you know how to operate it safely and correctly. Keep this manual in an easily accessible location for future reference.

- The warning symbols indicate important safety related information. To protect yourself and others from personal injury or damage to property, it is essential that you always read the warnings and information provided.

Danger

If the product is used without observing the information given under this symbol, serious injury or death may result.

Warning

If the product is used without observing the information given under this symbol, injury or death may result.

Caution

If the product is used without observing the information given under this symbol, minor personal injury, damage to the equipment, or loss of valuable data may result.

Cautions relating to the operating environment

- To protect the high-precision technology contained in this product, never use or store the recorder in any of the following environments:
 - Places where temperatures and/or humidity are high or undergo extreme changes, such as direct sunlight, beaches, locked cars, or near other heat sources (stove, radiator, etc.) or humidifiers.
 - In sandy or dusty environments.
 - Near flammable items or explosives.
 - In wet places, such as bathrooms or in the rain.
 - In places prone to strong vibration.
- Never drop the recorder or subject it to severe shock or vibration.
- The recorder may malfunction if it is used in a location where it is subject to a magnetic/ electromagnetic field, radio waves, or high voltage, such as near a TV set, microwave, video game, loud speakers, large monitor unit, TV/radio tower, or transmission towers. In such cases, momentarily turn the recorder off before further operation.
- Avoid recording or playing back near cellular phones or other wireless equipment, as they may cause interference and noise. If you experience noise, move the recorder further away from such equipment.
- Do not use organic solvents such as alcohol and lacquer thinner to clean the unit.

Precautions relating to reception:

- Radio reception will vary substantially depending on where you are using the radio. If the reception is poor, try moving the recorder near to a window and away from electrical products such as cellular phones, televisions, fluorescent lights etc.

Warning regarding data loss:

- Recorded content in memory may be destroyed or erased by operating errors, unit malfunction, or during repair work. It is recommended to back up and save important content to other media such as a computer hard disk.
- Olympus does not accept any liability for passive damages or damage of any kind incurred due to data loss resulting from a defect of the product, repair performed by a third party other than Olympus or an Olympus authorized service station, or for any other reasons.

Handling the recorder



Warning:

- **Do not use the recorder near flammable or explosive gases.**
- **Keep young children and infants away from the recorder.**
Always use and store the recorder out of the reach of young children and infants to prevent the following dangerous situations which could cause serious injury:
 - ① Becoming entangled in the recorder strap, causing strangulation.
 - ② Accidentally swallowing the battery, cards or other small parts.
 - ③ Accidentally being injured by the moving parts of the recorder.
- **Do not use or store the recorder in dusty or humid places.**
- **Do not disassemble, repair or modify the unit yourself.**

- **Use microSD/microSDHC memory cards only. Never use other types of cards.**

If you accidentally insert another type of card into the recorder, contact an authorized distributor or service center. Do not try to remove the card by force.

- **Do not operate the unit while driving or riding a vehicle (such as a bicycle, motorcycle, or car).**



Caution:

- **Stop using the recorder immediately if you notice any unusual odors, noise, or smoke emanating from it.**
Never remove the batteries with bare hands. Doing so may cause a fire or burn your hands.
- **Be careful with the strap.**
Be careful with the strap when carrying the recorder. It could easily catch on something and cause serious damage.
- **Do not leave the recorder where it may be subject to extremely high temperatures.**
Doing so may cause parts to deteriorate and, in some circumstances, cause the recorder to catch fire. Do not cover (such as with a blanket) the charger or AC adapter while it is being used. This could cause overheating, resulting in fire.
- **Handle the recorder with care to avoid getting a low-temperature burn.**
 - If the recorder contains metal parts, overheating can result in a low-temperature burn. Note the following:
 - When used for a long period, the recorder will get hot. If you hold the recorder while it is hot, you may suffer a low-temperature burn.

- In places subject to extremely cold temperatures, the temperature of the recorder may be lower than the ambient temperature. If possible, wear gloves when handling the recorder in cold temperatures.

Battery handling precautions

Follow these important guidelines to prevent batteries from leaking, overheating, burning, exploding, or causing electrical shock or burns.

Danger:

- Do not attempt to recharge alkaline, lithium or any other non-rechargeable batteries.
 - Batteries should never be exposed to flame, heated, short-circuited or disassembled.
 - Never heat or incinerate batteries.
 - Take precautions when carrying or storing batteries to prevent them from coming into contact with any metal objects such as jewelry, pins, fasteners, etc.
 - Never store batteries where they will be exposed to direct sunlight, or subjected to high temperatures in a hot vehicle, near a heat source, etc.
 - To prevent causing battery leaks or damaging their terminals, carefully follow all instructions regarding the use of batteries. Never attempt to disassemble a battery or modify it in any way by soldering it, etc.
 - Do not connect the battery directly to a power outlet or the cigarette lighter in an automobile.
- **If battery fluid gets into your eyes, flush your eyes immediately with clean, cold running water and seek medical attention immediately.**

Warning:

- Keep batteries dry at all times.
- If rechargeable batteries have not been recharged within the specified time, do not use them.
- Do not use a battery if it is cracked or broken.
- Never subject batteries to strong shock or continuous vibration.
- If a battery leaks, becomes discolored or deformed, or becomes abnormal in any other way during operation, stop using the recorder.
- If a battery leaks fluid onto your clothing or skin, remove the clothing and flush the affected area with clean, cold running water immediately. If the fluid burns your skin, seek medical attention immediately.
- Keep batteries out of the reach of children.
- If you notice anything unusual when using this product, such as abnormal noise, heat, smoke, or a burning odor:
 - ① remove the battery immediately, taking care not to burn yourself, and;
 - ② call your dealer or local Olympus representative for service.

**Caution:**

- Please recycle batteries to help save our planet's resources. When disposing of dead batteries, be sure to cover their terminals and always observe local laws and regulations.
- Always charge a rechargeable battery before using it for the first time, or if it has not been used for a long period.
- Rechargeable batteries have a limited life. When the recorder's operating time becomes notably shorter even after the rechargeable battery is fully charged under the specified conditions, replace the battery with a new one.

Getting started

Main features

1

Main features

- **The Built-in Stereo FM tuner means you can use the recorder as a radio (WS-813 only) (P.47).**
- **It supports the linear PCM format, which is capable of recording sound quality equivalent to that of CDs (WS-813, WS-812 only) (P.56).**
- **It supports a wide range of recording formats, including the MP3 format (MPEG-1/MPEG-2 Audio Layer 3) and the Windows Media Audio (WMA) format (P.56).**
- **You can play back WAV*, WMA, and MP3 format files transferred from a computer in addition to files recorded by the device itself.**
This allows you to use this recorder as a music player.
* WS-813, WS-812 only.
- **It supports high capacity recording media. Besides the internal memory, you can also record into a microSD card (P.23).**
- **A directional microphone feature has been included that allows switching between broad stereo recording and recording with a highly directional quality (WS-813 only) (P.57).**
- **It is equipped with a variety of features that support audio recording.**
With this recorder you can customize a variety of recording functions such as the recording sensitivity to suit the recording conditions and personal preferences (P.56).
- **It has a built-in Variable Control Voice Actuator (VCVA) function (P.57).**
- **The Low Cut Filter minimizes air conditioner noise and similar noises while recording (P.57).**
- **It has recording scene setting and playback scene setting functions to register the best setting according to the use (P.32, P.44, P.59, P.63).**
- **It is equipped with the [Calendar Search] function, convenient for searching for files (P.40).**
- **It features a [Voice Detect] function, which extracts just the voice portions from a recorded audio file, and a [Voice Playback] function, which plays back just the extracted voice portions (P.61, P.68).**
- **It also features a [Voice Balancer] function, which compensates for the low-volume portions of a recorded audio file, making them louder and therefore easier to understand (P.61).**

- **A Noise Cancel function (P.61) and a Voice Filter function* (P.61) cut noise and enable clear audio playback.**
* WS-811 only.
- **It features various repeat functions (P.43, P.62).**
- **You can change the playback equalizer settings (P.62).**
- **You can move or copy files between the internal memory and microSD card, and within the folders in the memory (WS-813, WS-812 only) (P.70).**
- **You can divide files (PCM*, MP3) that have been recorded with this recorder into two files (P.72).**
* WS-813, WS-812 only.
- **Index mark and temp mark features allow you to quickly find desired locations (P.42).**
- **The playback speed and tone* can be controlled (P.41).**
* WS-813, WS-812 only.
- **This recorder is compatible with USB 2.0, enabling fast data transfer to a computer.**
- **It has a USB charging function (WS-813, WS-812 only) (P.16).**
- **It has a backlight full-dot display (LCD panel).**

Identification of parts

1

Identification of parts

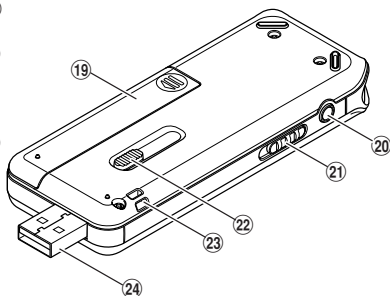
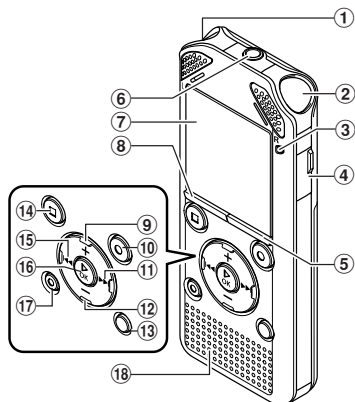

- ① Built-in stereo microphone (L)
- ② Built-in stereo microphone (R)
- ③ LED indicator light (LED)
- ④ Card cover
- ⑤ LIST button
- ⑥ MIC (Microphone) jack
- ⑦ Display (LCD panel)
- ⑧ MENU button
- ⑨ + button
- ⑩ REC (●) (Record) button
- ⑪ ►►► button
- ⑫ – button
- ⑬ SCENE/INDEX button
- ⑭ STOP (■) button
- ⑮ ◀◀◀ button
- ⑯ ► OK button
- ⑰ ERASE button

- ⑱ Built-in speaker
- ⑲ Battery cover
- ⑳ EAR (Earphone) jack
- ㉑ POWER/HOLD switch
- ㉒ USB connector slide lever
- ㉓ Strap hole
- ㉔ USB connector

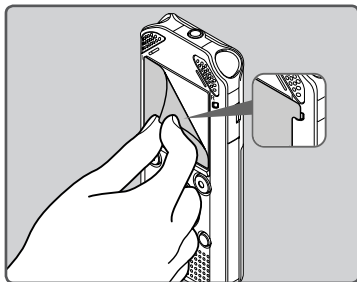

- Remove the screen protector from the display.

Display (LCD panel)

■ [Recorder] mode display:

Folder list display

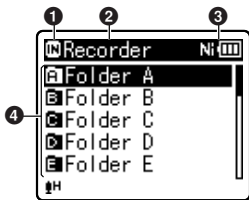

1 Recording media indicator

- [M]: Internal memory
- [C]: microSD card

2 Current folder name

3 Battery indicator

4 Folder name

File list display

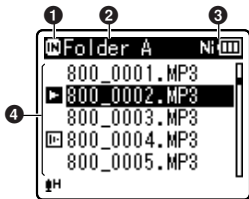

1 Recording media indicator

2 Current folder name

3 Battery indicator

4 File name

File display

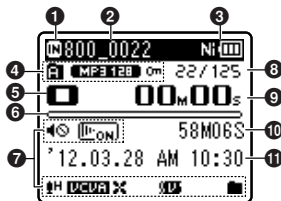

1 Recording media indicator

2 Current file name

3 Battery indicator

4 Folder indicator, Recording mode indicator, File Lock indicator

5 Recorder status indicator

- [R]: Record indicator
- [P]: Pause indicator
- [S]: Stop indicator
- [▶]: Play indicator
- [▶▶]: Forwarding indicator
- [◀◀]: Rewinding indicator
- [▶F]: F. Play indicator
- [▶S]: S. Play indicator
- [▶#]: Change playback tone indicator (sharp)
- [▶b]: Change playback tone indicator (flat)

6 Remaining memory bar indicator, Playback position bar indicator

7 Icon display (see P.13)

8 Current file number/ Total number of recorded files in the folder

9 Elapsed recording time, Elapsed playback time

10 Remaining recording time, File length

11 Level meter, Recording date and time

■ [Music] mode display:

List display ①

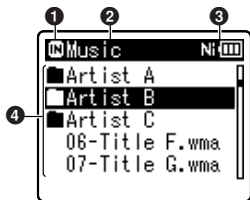

When there are files and folders in the folder

① Recording media indicator

[M]: Internal memory

[C]: microSD card

② Current folder name

③ Battery indicator

④ Folder name, File name

List display ②

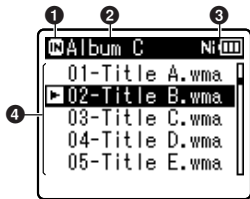

When there are only files in the folder

① Recording media indicator

② Current folder name

③ Battery indicator

④ File name

File display

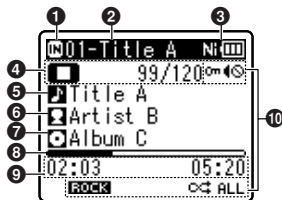

① Recording media indicator

② Current file name

③ Battery indicator

④ Recorder status indicator

[▶]: Play indicator

[■]: Stop indicator

[▶▶]: Forwarding indicator

[◀◀]: Rewinding indicator

[▶▶]: F. Play indicator

[◀◀]: S. Play indicator

[▶#]: Change playback tone indicator (sharp)

[▶b]: Change playback tone indicator (flat)

Current file number/ Total number of recorded files in the folder

⑤ Title name

⑥ Artist name

⑦ Album name

⑧ Playback position bar indicator

⑨ Elapsed playback time, File length

⑩ Icon display (P.13)

■ [FM Radio] mode display:

Radio reception display



For WS-813:

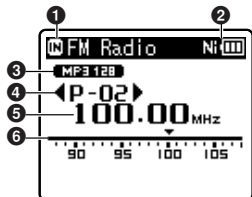

- ① Recording media indicator
- ② Battery indicator
- ③ Recording mode indicator
- ④ Preset number
- ⑤ Tuning frequency
- ⑥ Frequency bar indicator

Icon display (For all modes)

[MUTE]: Speaker muting
 [PLAY/PAUSE]: Voice Playback *1
 [VOLUME]: Voice Detect *1
 [RECORD]: Rec Level
 [VCVA]: VCVA
 [SYNC]: Voice sync
 [ROCK]: Equalizer

[LOW CUT]: Low Cut Filter
 [ZOOM MIC]: Zoom Mic *2
 [NOISE CANCEL]: Noise Cancel
 [VOICE BALANCER]: Voice Balancer *1
 [VOICE FILTER]: Voice Filter *3
 [ALL] [OFF] [ON]: Playback mode

*1 WS-813, WS-812 only. *2 WS-813 only. *3 WS-811 only.

Power supply

Inserting the battery

This recorder can be used with either a Ni-MH rechargeable battery or AAA alkaline battery.

1

Power supply

! For WS-813, WS-812:

- When charging the recorder, make sure that the supplied Ni-MH rechargeable battery (BR404) is in place.
- The supplied rechargeable battery is not fully charged. Before using the recorder or after long periods of disuse, it is recommended that you continuously charge the battery until full (☞ P.16).

! For WS-811:

This recorder cannot charge the rechargeable battery.

- 1 Lightly press down on the arrow and slide the battery cover open.

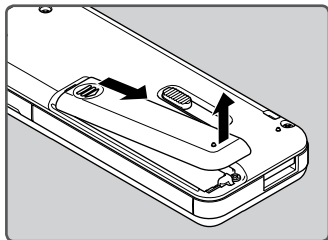

- 2 Insert the battery, observing the ⊕ and ⊖ polarities.

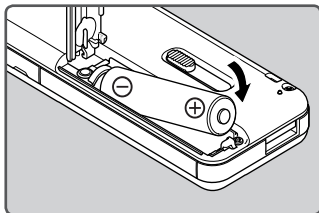

- 3 Close the battery cover completely by pressing down at (A), then sliding the cover towards (B).

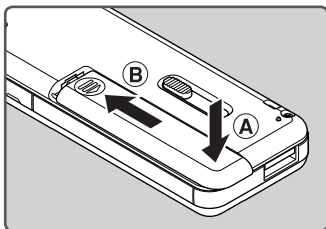

Notes

- A manganese battery cannot be used in this recorder.
- When the battery is changed, a AAA alkaline battery or Olympus Ni-MH rechargeable battery is recommended.
- Be sure to stop the recorder before replacing the battery. Unloading the battery while the recorder is in use may cause a malfunction resulting in the corruption of the file, etc. If you take out the battery during recording, you will lose your currently recorded file because the file header will not be able to close.

- If it takes longer than 15 minutes to replace the dead battery or if you take the battery in and out repeatedly at short intervals, you may have to re-enter the battery and time settings. In this case, **[Battery]** screen will appear. For more details, see “**Battery settings**”.
- Remove the battery if you are not going to use the recorder for an extended period of time.
- When replacing the rechargeable battery, be sure to use a Ni-MH rechargeable battery (optional). The use of other manufacturers' products can damage the recorder and should be avoided.

Battery settings

Select the battery type to match the battery you are using.

- 1 Replace the battery and turn on the recorder** (☞ P.14, P.19).
- 2 Press the + or – button to change the setting.**

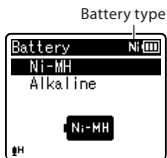

[Ni-MH] (Ni-MH icon):

Select when using the Olympus Ni-MH rechargeable battery (BR404).

[Alkaline] (Alkaline icon):

Select when using an alkaline battery.

- 3 Press the ▶OK button to complete the setting.**

- If the “**Hour**” indicator flashes in the display, see “**Setting the time and date [Time & Date]**” (☞ P.21).

Battery indicator

The battery indicator on the display changes as the battery loses power.



- When appears on the display, charge or replace the battery as soon as possible. When the battery has insufficient power to operate the recorder, and **[Battery low]** appear on the display and the recorder shuts down.

Note

- When a voice/music file is played, depending on the volume level the recorder may be reset due to a drop in the voltage output of the battery even if is displayed in the battery indicator. In this case, lower the volume of the recorder.

Charging by connecting to a computer via USB

! For WS-813, WS-812:

Before connecting via USB, exit HOLD mode (☞ P.20).

You can charge the battery by connecting to a PC's USB port. When charging, be sure to place the rechargeable battery (supplied) correctly into the recorder (☞ P.14).

Do not charge a primary battery such as an alkaline or lithium battery. It may cause battery leakage or heating, which may cause the recorder to malfunction.

1 Boot the PC.

2 Slide the USB connector slide lever in the direction indicated by the arrow so that the USB connector protrudes from the recorder.

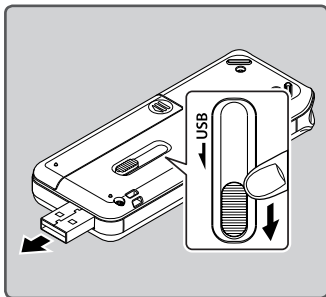

3 Make sure that the recorder is in stop mode, and connect to the PC's USB port.

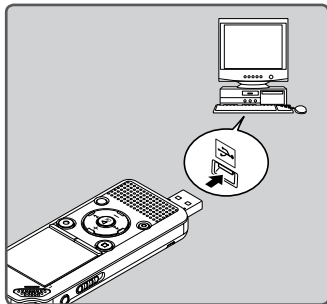

4 Press the ►OK button to start charging.



- While [Press OK to start charging] is flashing, press the ►OK button.

5 Charging is completed when the battery indicator shows [■].

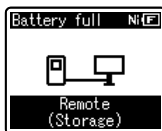

Charging time: approximately 3 hours*

- * This is the approximate time when charging the rechargeable battery fully from flat at room temperature.

The charging time depends on the amount of remaining power and the state of the battery.

Connecting the USB-type AC adapter (optional) to charge

! For WS-813, WS-812:

- Before connecting the AC adapter, switch the USB connection setting to **[AC Adapter]** (☞ P.73).
- Before connecting via USB, exit HOLD mode (☞ P.20).

You can charge the recorder by connecting it to the USB-type AC adapter (A514) (optional).

1 Plug the recorder into the AC adapter's USB port.

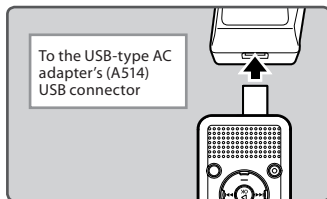

2 Plug the AC adapter into the AC outlet.

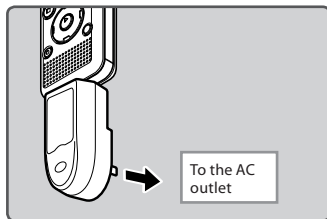

3 Press the ►OK button to start charging.

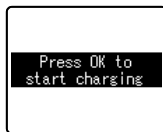

- While **[Press OK to start charging]** is flashing, press the ►OK button.

4 Charging is completed when [Battery full] is displayed.

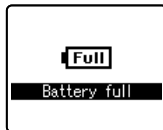

Notes

- The recorder cannot be charged if the PC is not turned on, or if the PC is in standby, hibernate, or sleep mode.
- Do not charge the recorder with the USB hub connected.
- Insert the supplied rechargeable battery and set **[Battery]** to **[Ni-MH]**. If **[Battery]** is set to **[Alkaline]**, you cannot recharge (☞ P.15, P.65).
- You cannot charge the battery if **[C]***1 or **[H]***2 is blinking. Charge the battery at a temperature in the range of 5°C to 35°C (41°F to 95°F).
 - *1 **[C]**: The surrounding temperature is too low.
 - *2 **[H]**: The surrounding temperature is too high.
- When the recorder's operating time becomes notably shorter even after the battery is fully charged, replace the battery with a new one.

- Use the dedicated USB cable. If any other company's cable is used, it may lead to malfunction of the recorder. Also, never use this dedicated cable with any other company's products.
- If you would like to charge the recorder using the **[Composite]** setting, select **[Optional]** in the USB connection settings, then connect the recorder to a PC. Selecting **[AC Adapter]** in the **[USB Connection]** display will enable you to charge the recorder (see P.73).

Cautions concerning the rechargeable battery

Read the following descriptions carefully before using the Ni-MH rechargeable battery.

Discharging:

The rechargeable battery self-discharges while not in use. Be sure to charge it fully before use.

Operating temperature:

The rechargeable battery is a chemical product. The efficiency of the rechargeable battery may fluctuate even when the battery is operating within the recommended temperature range. This is an inherent nature of such products.

Recommended temperature range:

When operating the recorder:

0°C - 42°C / 32°F - 107.6°F

Charging:

5°C - 35°C / 41°F - 95°F

Storage for a long period:

-20°C - 30°C / -4°F - 86°F

Using the rechargeable battery outside the above temperature range may result in declining efficiency and a shorter battery life. In order to prevent battery leakage or rust, remove the rechargeable battery from the recorder when you will not be using it for a long time, and store it separately.

Notes

- This recorder is designed to fully charge the battery regardless of its energy level. However, for best results when charging a newly purchased rechargeable battery or a battery that has not been used for a long time (more than one month), it is recommended to repeat the process of fully charging the battery and then letting it discharge 2 to 3 times.

- When disposing of the rechargeable battery, always observe the local laws and regulations. Contact your local recycling center for proper disposal methods.
- If the Ni-MH rechargeable battery is not fully discharged, protect against short-circuiting (e.g. by taping the contacts) before disposal.

For customers in Germany:

Olympus has a contract with the GRS (Joint Battery Disposal Association) in Germany to ensure environmentally friendly disposal.

Turning on/off the power

When the recorder is not being used, turn the power off to reduce battery consumption. Existing data, mode settings, and clock settings are not lost when the power is turned off.

Turning on the power

While the recorder is turned off, slide the **POWER/HOLD** switch in the direction of the arrow.

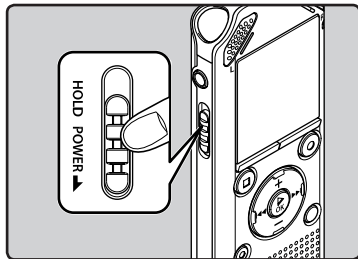

- The power turns on.

Turning off the power

Slide the **POWER/HOLD** switch in the direction of the arrow, and hold it for **0.5 seconds or longer**.

- The power turns off.
- The resume function remembers the stop position before the power is turned off.

Power save mode

If the recorder is on but is not used for 10 minutes or longer (default), the display shuts off and the recorder goes into power save mode (P.65).

- To exit power save mode, press any button.

HOLD

If you set the recorder to HOLD mode, the current settings will be preserved and all buttons will be disabled. This feature is useful when the recorder has to be carried in a bag or pocket. This mode can also prevent you from accidentally stopping recording.

Setting the recorder to HOLD mode

Slide the **POWER/HOLD** switch to the **[HOLD]** position.

1

HOLD

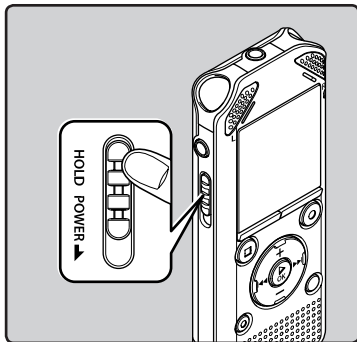

Exiting HOLD mode

Slide the **POWER/HOLD** switch to the **(A)** position.

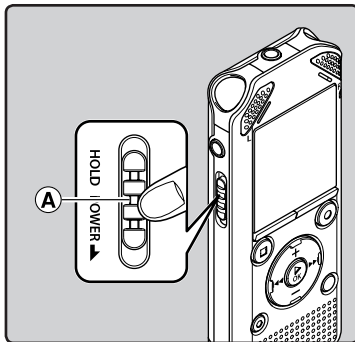

- After **[Hold]** appears on the display, the recorder is set to HOLD mode.

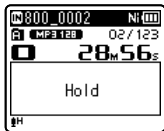

Notes

- If you press any button while the recorder is in HOLD mode, the clock display lights for 2 seconds, but the recorder does not operate.
- If HOLD is applied during playback (recording), operation is disabled with the playback (recording) state unchanged (When playback has ended or recording has ended due to the remaining memory being used up, the recorder stops).

Setting the time and date [Time & Date]

If you set the time and date before using the recorder, recording time and date information is automatically stored for each file. Setting the time and date beforehand enables easier file management.

When you use the recorder for the first time, or when the battery is inserted after the recorder has not been used for a long time, [Set time & date] will appear. When "Hour" is flashing, conduct setup from Step 1.

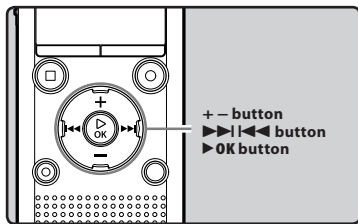

1 Press the ►► or ◀◀ button to select the item you want to set.

- Select "Hour", "Minute", "Year", "Month" or "Day" by moving the flashing position.



2 Press the + or – button to change the value.

- Follow the same steps by pressing the ►► or ◀◀ button to select the next item, and pressing the + or – button to change the value.
- You can select between 12 and 24 hour display by pressing the LIST button while setting the hour and minute.

Example: 10:38 P.M

10:38 PM (Initial setting) ↔ 22:38

- You can select the order of "Month", "Day" and "Year" by pressing the LIST button while setting these items.

Example: March 24, 2012

3M 24D 2012Y (Initial setting)

24D 3M 2012Y

2012Y 3M 24D

3 Press the ►OK button to complete the setting.



- The clock will start from the set date and time. Press the ►OK button when you want the clock to start.

Note

- If you press the ►OK button during the setup operation, the recorder will save the items that were set to that point.

Changing the time and date

While the recorder is in stop mode, press and hold the **STOP** (■) button to display [Time & date] and [Remain]. If the current time and date are not correct, set them using the procedure below.

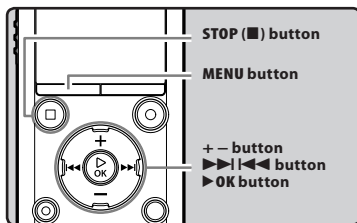

1 While the recorder is in stop mode, press the MENU button.

- The menu will appear on the display (☞ P.53).

2 Press the + or - button to select [Device Menu] tab.

- You can change the menu display by moving the settings tab cursor.



3 Press the ▶OK button to move the cursor to the item you want to set.

- [Device Menu] appears on the display.

4 Press the + or - button to select [Time & Date].



5 Press the ▶OK button.

- [Time & Date] appears on the display.
- "Hour" flashes on the display, indicating the start of the Time and Date setup process.

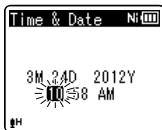

The following steps are the same as Step 1 through Step 3 of "Setting the time and date [Time & Date]" (☞ P.21).

6 Press the STOP (■) button to close the menu screen.

Inserting and ejecting a microSD card

The “microSD” indicated in the instruction manual refers to both microSD and microSDHC. This recorder enables you to store data not only to the internal memory but also to a commercially available microSD card.

Inserting a microSD card

- 1 While the recorder is in stop mode, open the card cover.

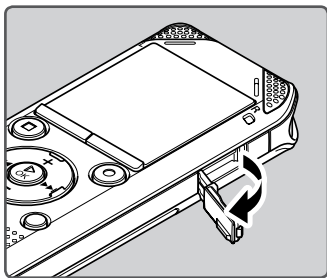

- 2 With the microSD card facing the correct way, insert it into the card slot as shown in the diagram.

- Insert the microSD card, keeping it straight.

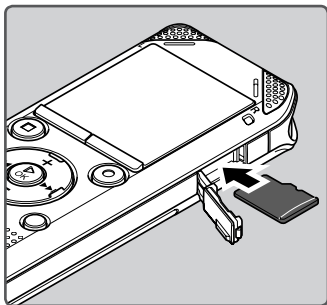

- Inserting the microSD card in the wrong way or at an angle could damage the contact area or cause the microSD card to jam.
- If the microSD card is not inserted all the way, data may not be recorded on the microSD card.

- 3 Close the card cover securely.

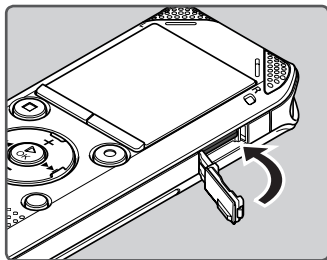

- When you insert the microSD card, the recording media changeover display will appear.

- 4 To record on a microSD card, press the + or – button and select [Yes].

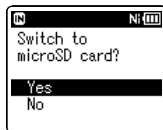

- 5 Press the ► OK button to complete the setting.

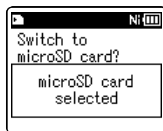

1

Inserting and ejecting a microSD card

Notes

- It is possible to switch the recording media over to the internal memory (☞ P.65).
- In some cases microSD cards that have been formatted (initialized) by another device, such as a computer, may not be recognized. Be sure to format microSD cards with this recorder before using them (☞ P.74).

Ejecting a microSD card

- 1 While the recorder is in stop mode, open the card cover.
- 2 Push the microSD card inward to unlock it, and let it eject partially.

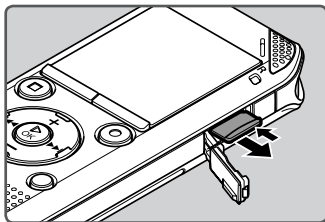

- The microSD card is visibly out of the slot and can be removed safely.
- If you eject the microSD card when **[Memory Select]** is set to **[microSD card]**, **[Memory Select]** will automatically change to **[Internal memory selected]**.

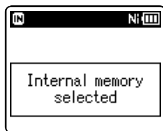

3 Close the card cover securely.

Notes

- Quickly moving your finger away after pushing the microSD card inward may cause it to eject forcefully out of the slot.
- Some microSD cards or microSDHC cards may not be recognized correctly depending on the manufacturer or type of card due to compatibility issues with this recorder.
- See the Olympus website for a list of microSD cards that have been confirmed to operate with this recorder in conditions prescribed by Olympus. The website <http://olympus-imaging.jp/> introduces manufacturers and types of microSD cards confirmed to be compatible. Please note, however, this is not meant to guarantee that microSD cards will operate. Some microSD cards may not be recognized correctly due to circumstances such as changes in manufacturer specifications.
- If a microSD card is not recognized, remove the microSD card and then insert it again to see if the recorder recognizes the microSD card.
- Always read the instructions that come with your microSD card before using.
- Processing speed may be slower with some types of microSD cards. Processing performance may also be reduced due to repeated writing and deleting. If that happens, reformat the microSD card (☞ P.74).

[Home] display operations

You can use the recorder not only as a voice recorder and a music player but also as a radio*.

* WS-813 only.

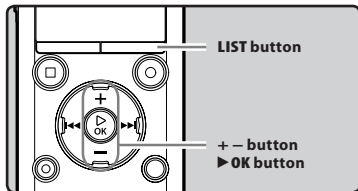

1 Press the LIST button repeatedly to set the [Home] display.

- [Home] appears on the display.



2 Press the + or - button to select the mode.



3 Press the ▶ OK button.

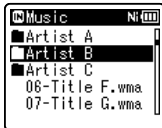

When [Recorder] is selected:

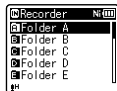

The recorder will go into [Recorder] mode. You will be able to record and play back files recorded by the recorder (☞ P.29, P.36).

When [Music] is selected:

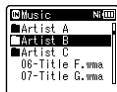

The recorder will go into [Music] mode, and you will be able to play back music files transferred to the recorder (☞ P.36).

When [Calendar Search]* is selected:



The recorder will go into [Calendar Search] mode, and you can search for files according to the recording date (☞ P.40).

* WS-813, WS-812 only

When [FM Radio]* is selected:

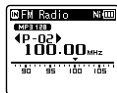

The recorder will go into [FM Radio] mode, and you will be able to receive FM radio (☞ P.47).

* WS-813 only

Note

- During recording, you cannot switch the mode without stopping the recorder.

Notes on the folders

The internal memory or a microSD card can be used as the recording media. Voice files and music files are separated into folders for voice recordings and folders for music playback that are organized and saved in a branching tree.

About the folders for voice recordings

[Folder A] - [Folder E] within the [Recorder] folder are the folders for voice recordings. When recording with this recorder, select any one of the five folders and then record.

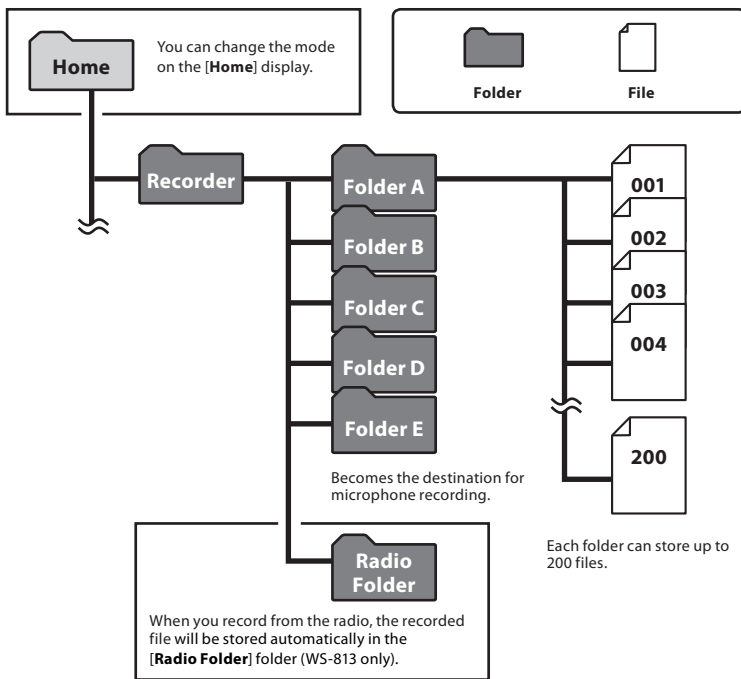

About the folders for music playback

When music files are transferred to the device using Windows Media Player, a folder is automatically created within the music playback folder which has a layered structure as shown in the diagram below. Music files that are in the same folder can be rearranged in preferential order and replayed (☞ P.69).

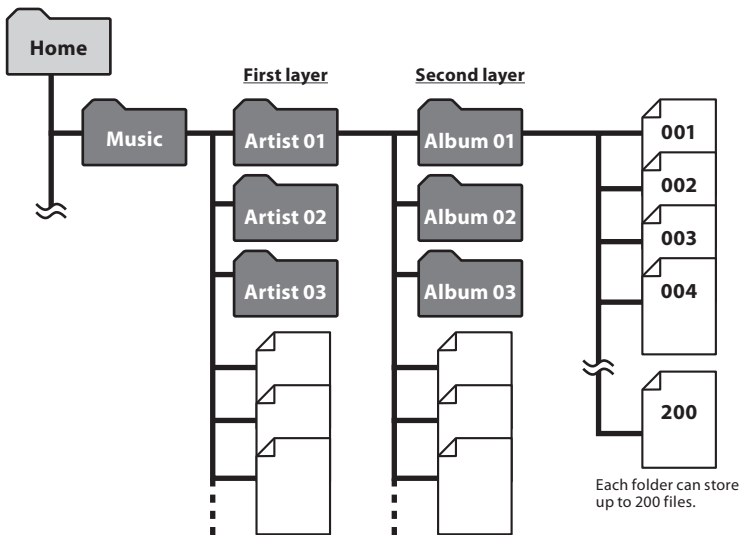

Up to 300* folders can be created under the [Music] folder, including [Music].

* For WS-811: 128 folders.

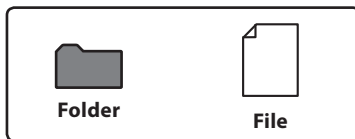

Selecting folders and files

Change folders while the recorder is stopped or during play. For information on the layered structure of the folders, see the section entitled “Notes on the folders” (P.26).

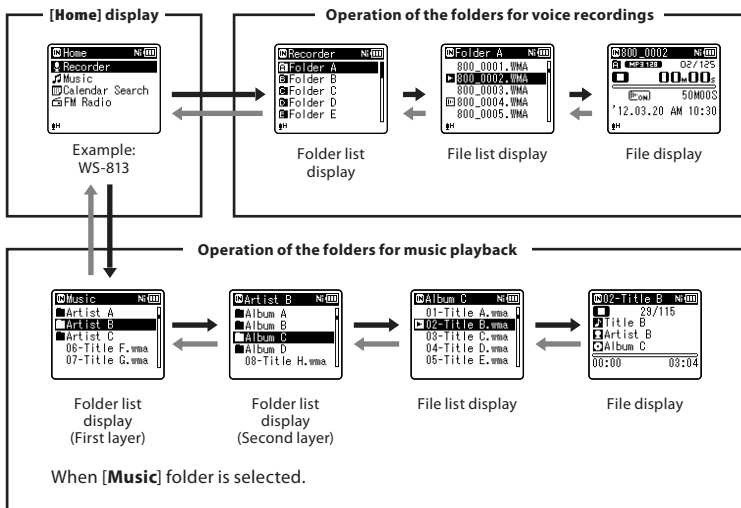

Moving through the levels

← Return: LIST button

Each time you press this button, you move up one level. The **◀◀** button can also serve as the **LIST** button on a list display.

- If you press and hold the **LIST** button while moving in a hierarchy of folders, you will return to the file display.

→ Proceed: ►OK button

Each time you press this button, you open the folder or file selected in the list display and proceed down one level.

- The **▶▶** button can also serve as the **►OK** button on a list display.

+ or – button

Select a folder or file.

[Home] display:

This display allows the mode of the recorder to be changed (P.25).

List display:

The folders and files stored in the recorder are displayed.

File display:

Information about the selected file is displayed. The recorder is in playback standby mode.

About recording

Recording

Before starting recording, select a folder among [A] to [E]. These five folders can be used to categorize recorded information according to type; for example, Folder [A] might be used to store private information, while Folder [B] might be dedicated to holding business information.

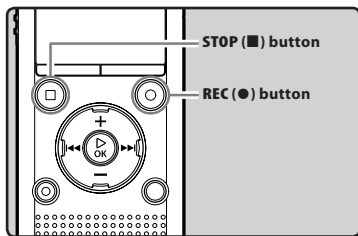

1 Select a recording folder (see P.26).

2 Press the REC (●) button to start recording.

- The LED indicator light turns on and [●] appears on the display.
- Turn the microphone in the direction of the source to be recorded.

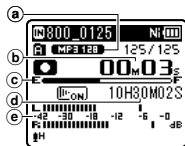

- (a) Recording mode indicator
- (b) Elapsed recording time
- (c) Remaining memory bar indicator
- (d) Remaining recording time
- (e) Level meter (changes according to the recording level and recording function settings)

- [Rec Mode] cannot be changed in recording standby mode or while recording. Configure this while the recorder is stopped (see P.56).
- The proper position of the built-in stereo microphone for performing stereo recording is over the display. If the microphone is below the display during recording, proper stereo recording is impossible because the original sound will be recorded in reverse phase.

3 Press the STOP (■) button to stop recording.

- [■] appears on the display.

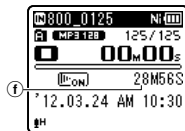

- (f) File length

Notes

- To ensure that you do not lose the beginning of the recording, verify that the LED indicator light or the mode indicator is lit on the display.
- When the remaining recording time is less than 60 seconds, the LED indicator light starts flashing. When the remaining recording time drops to 30 and then 10 seconds, the light flashes faster.

- **[Folder full]** will appear when recording cannot be continued. Select another folder or delete unnecessary files before recording (☞ P.45).
- **[Memory full]** will appear when the memory is full. Delete unnecessary files before recording any further (☞ P.45).
- When a microSD card is inserted into the recorder, be sure to confirm the recording media as either **[Internal memory]** or **[microSD card]** so that there is no mistake (☞ P.65).
- If the **REC (●)** button is pressed when a function other than the record function is specified, **[Cannot record in this folder]** is displayed. Select a folder from **[Folder A]** through **[Folder E]** and start recording again.
- Processing speed may be slower with some types of microSD cards. Processing performance may also be reduced due to repeated writing and deleting. If that happens, reformat the microSD card (☞ P.74).
- We recommend formatting the recording media in the recorder before recording (☞ P.74).

For WS-813:

- You can record FM radio in **[FM Radio]** mode (☞ P.47).
- This recorder is designed to be able to record cleanly and evenly, even when the volume of the source sound changes significantly. However, even higher sound quality recordings can be achieved by adjusting the recording level manually (☞ P.56).

■ **It is possible to record data exceeding 2GB:**

**For WS-813, WS-812:**

Recording will continue even if the volume of a single file exceeds 2 GB in linear PCM format recording.

- The data is saved every 2 GB in separate files. It is treated as multiple files during playback.
- If the recording exceeds 2 GB, the number of files in the folder may exceed 200. The 201st and later files are not recognized by the recorder, so check by connecting the recorder to a PC.

Settings relating to recording

[Rec Level] (<small>ESP</small> P.56)	Sets the recording sensitivity.
[Rec Mode] *1 (<small>ESP</small> P.56)	Sets the recording rate for each recording format.
[Zoom Mic] *2 (<small>ESP</small> P.57)	Sets the directivity of the built-in stereo microphone.
[Low Cut Filter] (<small>ESP</small> P.57)	This function can reduce noise from air conditions and projectors and other similar noises.
[VCVA] (<small>ESP</small> P.57)	Sets the threshold level for the Variable Control Voice Actuator (VCVA).
[V-Sync. Rec] (<small>ESP</small> P.58)	Sets the start level for voice sync recording.
[Rec Scene] (<small>ESP</small> P.59)	Sets recording settings to suit the recording conditions or environment.

*1 This function will be fixed to the following configurations while the recorder is in [FM Radio] mode (WS-813 only).

- [PCM]: 44.1 kHz/16bit
- [MP3]: 128 kbps
- [WMA]: 128 kbps

*2 WS-813 only

Pause

While the recorder is in recording mode, press the REC (●) button.

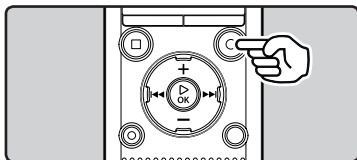

- [●] will appear on the display.
- The recorder will stop if left on pause for more than 60 minutes.

Resume Recording:

Press the REC (●) button again.

- Recording will resume at the point of interruption.

To quickly check recorded contents

While the recorder is in recording mode, press the ►OK button.

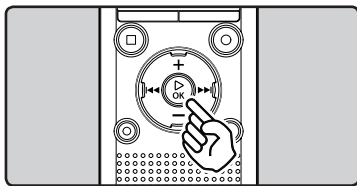

- [▶] will appear on the display.
- Recording will stop, and the file that was just recorded will be played back.

For WS-813:

- When the ►OK button is pressed while audio is being recorded in [FM Radio] mode, the recorder automatically enters [Recorder] mode, and the last file recorded from the FM radio is played back.

Listening while audio is recorded

If you start recording after inserting the earphones into the **EAR** jack on the recorder, you can hear the audio being recorded. The recording monitor volume can be adjusted by pressing the + or – button.

Connect the earphones to the EAR jack on the recorder.

- After recording has started, you can hear the audio being recorded through the earphones.

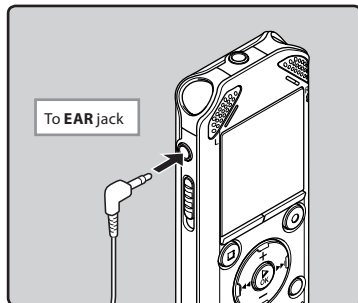

Notes

- You cannot control the recording level using the volume button.
- To avoid hurting your ears, turn down the volume before inserting the earphones into your ears.
- Do not place earphones near a microphone as this may cause feedback.
- If an external speaker is connected while recording, there is a risk that audio feedback will occur.

Changing the recording scene [Rec Scene]

You can easily change the recording settings by selecting the scene which best matches your usage (see P.59).

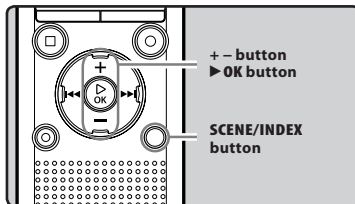

- While the recorder is in stop mode, press and hold the **SCENE/INDEX** button.
- Press the + or – button to select **[Rec Scene]**.

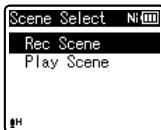

- Press the **▶ OK** button.
- Press the + or – button to select the recording environment.

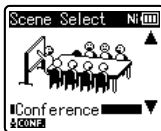

- Press the **▶ OK** button.

Recommended settings according to the recording conditions

The recorder is initially set to [WMA 128kbps] mode so that you can make high quality stereo recordings immediately after purchase. The various recording functions can be configured in detail to suit the recording conditions. The following table shows the recommended settings for some example recording conditions.

Recording conditions	Recommended settings			
	[Rec Mode] (☞ P.56)	[Rec Level] (☞ P.56)	[Low Cut Filter] (☞ P.57)	[Zoom Mic] *1 (☞ P.57)
Lectures in large rooms	[PCM]: [44.1kHz/16bit] *2 [MP3]: [128kbps] or more [WMA]: [128kbps]	[High]	[On]	[+6]
Conferences with a large number of people	[MP3]: [128kbps] or more [WMA]: [128kbps]			[Off]
Meetings and business negotiations with a small number of people	[MP3]: [128kbps] [WMA]: [128kbps]	[Middle]		
Dictation with a lot of background noise	[WMA]: [64kbps]	[Low]		
Music playing, wild birds singing, and railway sounds	[PCM]: [44.1kHz/16bit]*2	Set the recording sensitivity according to the volume being recorded.	[Off]	

*1 WS-813 only. *2 WS-813, WS-812 only.

File names are automatically created for files recorded by this recorder.

813_0001.WMA

① ② ③

① **User ID:**

This is the user ID name that has been set on the Digital Voice Recorder.

② **File number:**

A file number is consecutively assigned regardless of changes in the selected recording media.

③ **Extension:**

This is the file name extension indicating the recording format used when recording with this recorder.

- Linear PCM format* .WAV
- MP3 format .MP3
- WMA format .WMA

* WS-813, WS-812 only.

Recording from an external microphone or other device

An external microphone or other device can be connected and audio can be recorded. Connect as follows according to the device to be used.

- Do not plug/unplug devices into the recorder's jack while it is recording.

■ Recording with an external microphone:

Connect an external microphone to the MIC jack of the recorder.

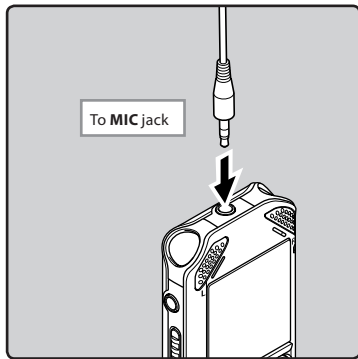

Applicable external microphones (optional) (E38 P.88)

Stereo microphone: ME51S

The built-in large-diameter microphone enables sensitive stereo recording.

2 channel microphone (omni-directional): ME30W

These highly sensitive omni-directional microphones are supported by plug-in power and are well-suited to recording musical performances.

Compact Gun Microphone (unidirectional): ME31

This directional microphone is useful for various types of recording such as outdoor recording of wild birds singing.

Compact zoom microphone (unidirectional): ME32

This microphone is integrated with a tripod, making it suitable to place on a table for recording conferences or lectures at a distance.

Highly sensitive noise-cancellation monaural microphone (unidirectional): ME52W

This microphone is used to record audio at a distance while minimizing surrounding noise.

Tie clip microphone (omni-directional): ME15

This small unobtrusive microphone comes with a tie-clip.

Telephone pickup microphone: TP8

This earphone-type microphone can be placed into your ear while you are phoning. The voice or conversation from the phone can be recorded clearly.

Notes

- The built-in microphone becomes inoperable when an external microphone is plugged into the recorder's MIC jack.
- Microphones supported by plug-in power can also be used.
- When an external monaural microphone is used while [Rec Mode] is set to a stereo recording mode, audio is recorded to the L channel only (E38 P.56).
- When an external stereo microphone is used while [Rec Mode] is set to a monaural recording mode, audio is recorded to the L channel only (E38 P.56).

■ Recording audio from another device with this recorder:

Audio can be recorded when you have connected the audio output terminal (earphone jack) of another device and the **MIC** jack of the recorder using the connecting cord KA333 (optional) for dubbing.

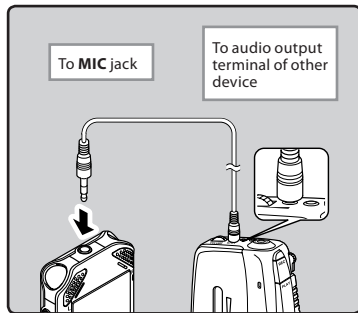

Note

For WS-813:

- If you are unable to produce a clear after recording with this recorder even after adjusting the recording level (P.56), this could potentially be because the output level for the connected devices is too high or too low. When external devices are connected, perform a test recording and then adjust the output level for the external devices.

For WS-812, WS-811:

- The recording level cannot be adjusted on this recorder. When an external device is connected, perform a test recording and then adjust the output level on the external device.

■ Recording audio from this recorder with another device:

Audio from this recorder can be recorded to another device by connecting the audio input terminal (microphone jack) of the other device and the **EAR** jack of this recorder using the connecting cord KA333 (optional).

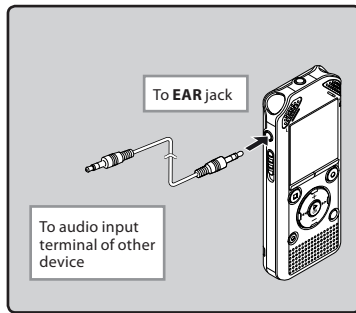

Note

- When you adjust the various sound quality settings related to playback on the recorder, the audio output signal sent out from the **EAR** jack is also adjusted (P.61, P.62).

About playback

Playback

The recorder can play back WAV*, MP3 and WMA format files. To play back a file recorded with another machine, you need to transfer (copy) it from a computer.

* WS-813, WS-812 only.

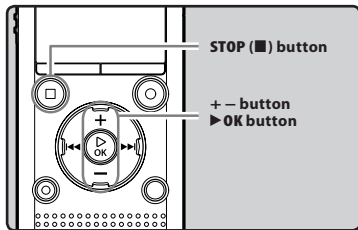

3
Playback

1 Select the file to be played back from the folder that contains it (see P.28).

2 Press the ► OK button to start playback.

- [▶] appears on the display.



- (a) Recording media indicator, File name
Folder indicator
- (b) Elapsed playback time
- (c) Playback position bar indicator
- (d) File length
- (e) Recording date and time

3 Press the + or – button to adjust the volume.

- The volume can be adjusted within the range of [00] to [30].

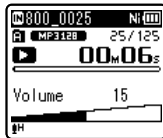

4 Press the STOP (■) button at any point where you want to stop playback.

- [■] appears on the display.
- Pressing this button stops the file being played back. If the resume function has been activated, the stop location is registered, even if the power is turned off. The next time the power is turned on, playback is resumed from the registered stop location.

Settings relating to playback

[Voice Playback] *1 *3 (<small>ESP</small> P.61)	Only the voice portions from a recorded audio file are played back.
[Noise Cancel] *3 (<small>ESP</small> P.61)	If recorded audio is difficult to understand because of noisy surroundings, adjust the Noise Cancel setting level.
[Voice Balancer] *1 *3 (<small>ESP</small> P.61)	When playing back a recorded audio file, the recorder compensates for any low-volume portions in the file.
[Voice Filter] *2 *3 (<small>ESP</small> P.61)	The recorder has a Voice Filter Function to cut low and high frequency tones during normal, fast, or slow playback, playback tone, and enable clear audio playback.
[Play Mode] (<small>ESP</small> P.62)	You can select the preferred playback mode.
[Equalizer] *4 (<small>ESP</small> P.62)	When listening to music, you can set your favorite sound quality by adjusting the equalizer setting.
[Skip Space] (<small>ESP</small> P.63)	The skip interval can be set.
[Play Scene] (<small>ESP</small> P.63)	Playback settings of your choice can be saved to suit different sound qualities and playback methods.

*1 WS-813, WS-812 only.

*2 WS-811 only.

*3 Function active only in **[Recorder]** mode.

*4 Function active only in **[Music]** mode.

Playback through the earphones

The earphones can be connected to the **EAR** jack of the recorder for listening.

- When the earphones are used, the recorder speaker is switched off.

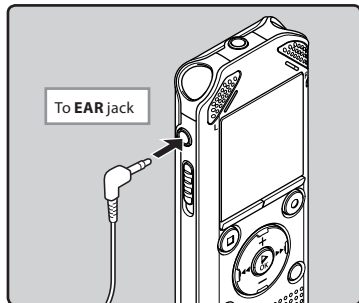

Notes

- To avoid hurting your ears, turn down the volume before inserting the earphones into your ears.
- When using the earphones, do NOT set the volume too high. Listening at very high volume may lead to hearing loss.

Forwarding

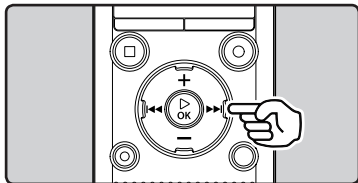

While the recorder is in stop mode in the file display, press and hold the **▶▶|** button.

- [▶▶] appears on the display.
- When you release the **▶▶|** button, forwarding stops. Press the **▶OK** button to start playback from where forwarding stopped.

While the recorder is in playback mode, press and hold the **▶▶|** button.

- When you release the **▶▶|** button, the recorder resumes normal playback.
- If there is an index mark or temp mark within the file, the recorder stops at that location (☞ P.42).
- The recorder stops when it reaches the end of the file. Continue pressing the **▶▶|** button to continue forwarding from the beginning of the next file.

Rewinding

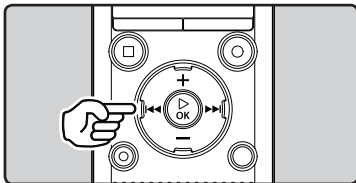

While the recorder is in stop mode in the file display, press and hold the **◀◀** button.

- [◀◀] appears on the display.
- When you release the **◀◀** button, rewinding stops. Press the **▶OK** button to start playback from where rewinding stopped.

While the recorder is in playback mode, press and hold the **◀◀** button.

- When you release the **◀◀** button, the recorder resumes normal playback.
- If there is an index mark or temp mark within the file, the recorder stops at that location (☞ P.42).
- The recorder stops when it reaches the beginning of the file. Continue pressing the **◀◀** button to continue rewinding from the end of the previous file.

Locating the beginning of a file

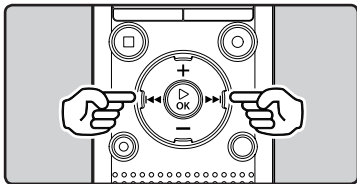

While the recorder is in stop mode or playback mode, press the ►► button.

- The recorder skips to the beginning of the next file.

While the recorder is in playback mode, press the ◀◀ button.

- The recorder skips to the beginning of the current file.

While the recorder is in stop mode, press the ◀◀ button.

- The recorder skips to the beginning of the previous file. If the recorder is in the middle of a file, it will return to the beginning of the file.

While the recorder is in playback mode, press the ◀◀ button twice.

- The recorder skips to the beginning of the previous file.

Notes

- When you skip to the beginning of the file during playback, the recorder stops at the position of the index mark or temp mark. Index marks and temp marks are skipped when you perform this operation in stop mode (P.42).
- When [Skip Space] is set to a setting other than [File Skip], the recorder skips forward/reverse by the specified time and then starts playback (P.63).

About music files

In cases where the recorder is unable to play back music files that have been transferred to it, check to make sure that the sampling rate and bit rate are in the range where playback is possible. Combinations of sampling rates and bit rates for music files which the recorder can play back are given below.

File format	Sampling frequency	Bit rate
WAV format*	44.1 kHz	16 bit
MP3 format	MPEG1 Layer3: 32 kHz, 44.1 kHz, 48 kHz MPEG2 Layer3: 16 kHz, 22.05 kHz, 24 kHz	From 8 kbps up to 320 kbps
WMA format	8 kHz, 11 kHz, 16 kHz, 22 kHz, 32 kHz, 44.1 kHz, 48 kHz	From 5 kbps up to 320 kbps

* WS-813, WS-812 only.

- Variable bit rate MP3 files (in which conversion bit rates can vary) may not be played back properly.
- For WAV files, this recorder can only play back those in the linear PCM format. WAV files other than these cannot be played back.
- Even if the file format is compatible for playback on this recorder, the recorder does not support every encoder.

Searching for a file

! For WS-813, WS-812:

You can search for voice files by the date they were recorded. As long as you know the date, you can quickly find a file even if you have forgotten what folder it is in. It is only possible to search for files saved in the voice recordings folder (a) to (b).

3 Playback

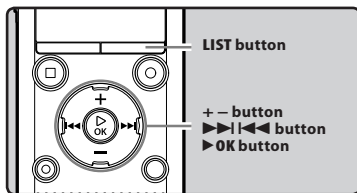

1 Press the LIST button repeatedly to set the [Home] display.

2 Press the + or - button to select [Calendar Search].



3 Press the OK button.

- [Calendar Search] will appear on the display.



- (a) Current date
- (b) Date when a file was recorded

- Dates with recorded files are shown with underbars.

4 Press the +, -, >>> or <<< button to select the date.



(c) Selected date

>>>, <<< buttons:

Move to the previous/next day.

+, - buttons:

Move to the previous/next week.

- Press the STOP (■) button to return to the [Home] display.

5 Press the OK button.

- Files recorded on the date selected are displayed in a list.

6 Press the + or - button to select a file.

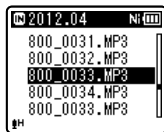

- Press the <<< button to return to the previous screen.

7 Press the OK button to start playback.

Changing the playback sound

You can change the playback speed and tone*. Changing the playback speed is useful when you want to speed-listen to the contents of a lecture or slow down the speed of a foreign-language phrase that you couldn't catch.

* WS-813, WS-812 only.

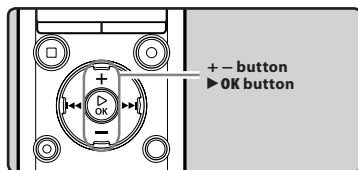

- 1 While the recorder is in playback mode, press the ▶ OK button.

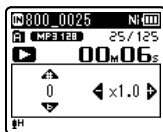

- 2 Press the + or - button or the ▶▶ or ◀◀ button to make it easier to catch what is being said.

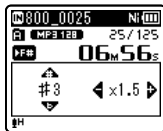

▶▶, ◀◀ buttons:

Change the playback speed.

+ , - buttons*:

Change the playback tone.

* WS-813, WS-812 only.

- If you are still having trouble catching the words after changing the playback speed, you can make the voice clearer by changing the tone.

- 3 Press the ▶ OK button.

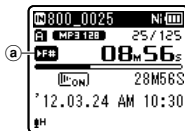

- a Playback speed/ playback tone indicator
- Even if playback is stopped, the modified playback speed and tone are retained.

Limits of fast playback

Normal operation may not be available depending on the sampling frequency and the bit rate of the file to be played back. In such a case, reduce the speed of fast playback.

Notes

- As in normal playback mode, you can stop playback, cue a file, or insert an index or temp mark in playback speed/ playback tone* modes as well (☞ P.42).
* WS-813, WS-812 only.
- When using the playback speed/ tone function, the following functions are not available.
 - [Voice Playback] (WS-813, WS-812 only) (☞ P.61)
 - [Noise Cancel] (☞ P.61)

Setting an index mark or a temp mark

If index marks and temp marks have been placed into your files, you can quickly find a location you want to listen to when you are fast forwarding, fast rewinding, or cuing a file. Index marks can only be placed into files created by Olympus voice recorders, but temp marks can be used to temporarily remember desired locations.

3

Playback

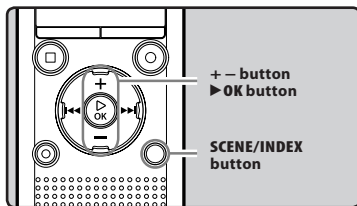

1 While the recorder is in recording mode or playback mode, press the SCENE/INDEX button.

- A number appears on the display and an index mark or temp mark is placed into the file.



- Even after an index or temp mark has been placed into a file, recording or playback will continue so you can place index or temp marks in other locations in a similar manner.

Clearing an index mark or a temp mark

- Select a file that contains index or temp marks you wish to erase.
- Press the **▶▶|** or **|◀◀** button to select the index or temp mark to be erased.



- While the index or temp number is displayed for approximately 2 seconds on the display, press the **ERASE** button.

- The index or temp mark is erased.



- Index or temp numbers after the erased index or temp number automatically decrement by 1.

Notes

- Temp marks are temporary markings, so if you transmit a file to a PC or move it using a PC, the marks will automatically be erased.
- Up to 99 index and temp marks can be set in a file. If you try to set more than 99 index or temp marks, the **[No more can be set]** message appears for index marks and the **[No more can be set]** message appears for temp marks.
- Index or temp marks cannot be set or erased in a locked file (P.55).

How to begin segment repeat playback

This function enables repeated playback of part of the file being played.

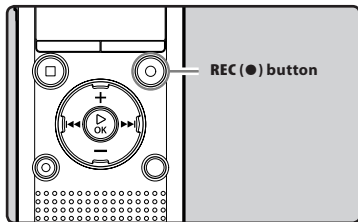

- 1 Select a file that has a segment you would like to play back repeatedly, and start playback.
- 2 Press the REC (●) button at the position where you want to start segment repeat playback.

- [A] flashes on the display.

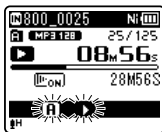

- While [A] is flashing, you can fast forward, rewind, or change the playback speed in the same way as in normal mode to find the end position (refer P.41).
- If the recorder reaches the end of the file while [A] is flashing, point [B] becomes the end of the file, and repeat playback starts.

- 3 Press the REC (●) button again at the position where you want to end segment repeat playback.

- The recorder continuously plays back the segment until segment repeat playback is canceled.

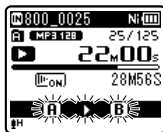

Note

- As in normal playback mode, the playback speed can be changed during segment repeat playback as well (refer P.41). If an index mark or temp mark is set or cleared during segment repeat playback, segment repeat playback is canceled and the recorder returns to normal playback mode (refer P.42).

Canceling the segment repeat playback function

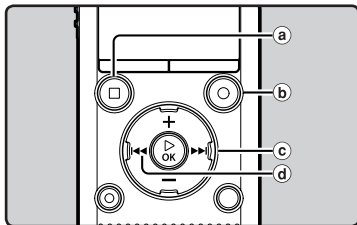

Pressing any of the following buttons releases segment repeat playback.

- Press the STOP (■) button**
Pressing the STOP (■) button releases segment repeat playback and stops playback.
- Press the REC (●) button**
Pressing the REC (●) button releases segment repeat playback, and it will return to normal playback mode.
- Press the ►► button**
Pressing the ►► button releases segment repeat playback, and makes the recorder skip to the beginning of the next file.
- Press the ◀◀ button**
Pressing the ◀◀ button releases segment repeat playback, and makes the recorder skip to the beginning of the current file.

Changing the playback scene [Play Scene]

If you register your preferred playback settings for the playback scenes, you can easily select the setting later (☞ P.63).

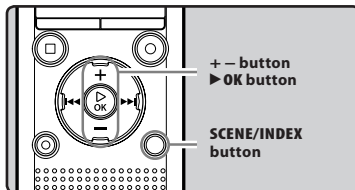

- While the recorder is in stop mode or playback mode, press and hold the SCENE/INDEX button.**
- Press the + or – button to select [Play Scene].**

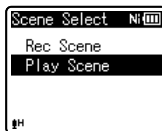

- Press the ► OK button.**
- Press the + or – button to select the playback scene.**



- Press the ► OK button.**

Erasing

Erasing files

A selected file can be erased from a folder. Also, all files in a folder can be erased simultaneously.

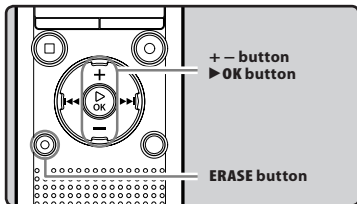

- 1 Select the file you want to erase (see P.28).
- 2 While the recorder is in stop mode in the file display, press the **ERASE** button.

- If an action is not selected within 8 seconds, the recorder returns to stop mode.

- 3 Press the **+** or **-** button to select **[All in folder]** or **[One file]**.



- 4 Press the **OK** button.
- 5 Press the **+** button to select **[Start]**.



- 6 Press the **OK** button.

- The display changes to **[Erasing!]** and erasing starts.
- **[Erased]** is displayed when the file is erased. File numbers are reassigned automatically.



Erasing a folder

You can erase files by deleting folders.

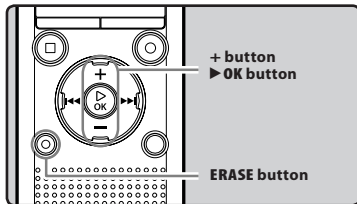

- 1 Select the folder you want to erase (see P.28).
- 2 While the recorder is in stop mode in the folder list display, press the **ERASE** button.

- If an action is not selected within 8 seconds, the recorder returns to stop mode.

3 Press the + button to select [Start].



4 Press the ► OK button.

- The display changes to **[Erasing!]** and erasing starts.
- **[Erased]** is displayed when the file is erased.

- Locked files and files set as read-only cannot be erased (☞ P.55).
- The default folders of the recorder, namely **[Recorder]** (including **[Folder A]** to **[Folder E]** and **[Radio Folder]***) and **[Music]** cannot be erased.

* WS-813 only.

- In the **[Music]** folder, all folders except **[Music]** can be deleted.
- If there is a file that cannot be recognized by the recorder, the file and the folder which contains that file will not be erased. Please connect the recorder to your PC to erase the file.
- Replace the battery with a new one in order to ensure that the battery does not go flat during processing. In addition, it may take over 10 seconds to complete processing. Never perform operations such as the following during processing, as such operations may damage the data.
 - ① Disconnect the AC Adapter during processing.
 - ② Remove the battery during processing.
 - ③ Remove the microSD card during processing when **[microSD card]** is selected as the recording media.

Notes

- You cannot recover a file once it has been erased. Please check carefully before erasing.
- When a microSD card is inserted into the recorder, be sure to confirm the recording media as either **[Internal memory]** or **[microSD card]** so that there is no mistake (☞ P.65).

About the FM radio (WS-813 only)

Using the FM radio

! For WS-813:

Radio reception varies substantially depending on where you are using the radio. If the reception is poor, adjust the antenna position or orientation, or place the recorder in a location where a radio signal can be easily received, such as by a window.

The recorder may not be able to receive an FM signal within or close to buildings



Move to a location where the signal can be easily received. Inside a building, broadcast signals are more easily received near windows.

Connecting the earphones

The supplied earphones function as an FM antenna. You cannot receive FM radio signals if the earphones are not connected.

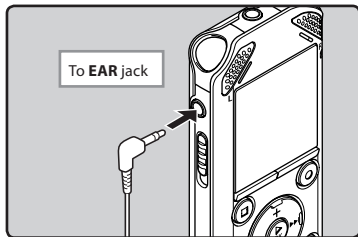

- Also note that you cannot receive radio signals in locations not reached by radio waves, such as areas outside the broadcast region and areas surrounded by mountains.

Notes

- Even within the broadcast region, radio signals may be difficult to receive in tunnels or underground roads, inside or in the shadow of buildings and apartment blocks that have concrete structure, and other similar locations. You may not be able to get radio reception in these locations.
- For best reception, avoid using the radio at the same time as a cellular phone, PC, television or other electrical product. Such products may cause noise.
- If you use the radio while the recorder is connected to the AC adapter (A514 etc.), noise may be generated. Always power the FM radio from the battery.

FM radio mode operations

! For WS-813:

Plug in the earphones

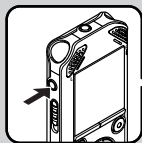

+ - button
▶▶|◀◀ button

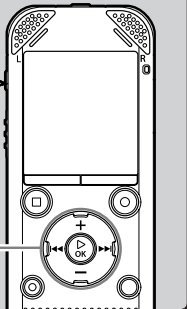

1 Set to [FM Radio] mode (☞ P.25).

- Change the mode to [FM Radio].

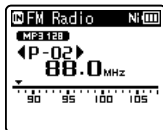

- To stop FM radio reception, press the **LIST** button to go to the [**Home**] display. From the [**Home**] display, you can change to a different mode.

2 Presetting radio stations.

Presetting radio stations automatically:

Automatically preset stations to make it easy to tune. For details, see “**Registering radio stations automatically [Auto-preset]**” (☞ P.49).

Adding a radio station to the preset stations:

Change the reception mode to manual reception, and adjust the frequency. The station you are tuned to can then be added (☞ P.50, P.51).

3 Press the ▶▶ or ◀◀ button to select a station.

- You can select a preset station.

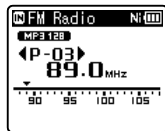

- You can also select a station which has not been preset. For details, see “**Changing the reception mode**” (☞ P.50).

4 Press the + or - button to adjust the volume.

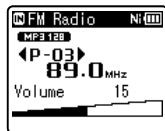

- The volume can be adjusted within the range of [00] to [30].

Settings relating to FM radio

[Auto-preset] (☞ P.49)	Automatically adds receivable stations to the preset stations.
[Scan Level] (☞ P.67)	Allows you to set the scan sensitivity for auto preset.
[Output] (☞ P.67)	Allows you to set the audio output of the FM radio.

Presetting radio stations automatically [Auto-preset]

Presetting radio stations makes it easy to find your desired station.

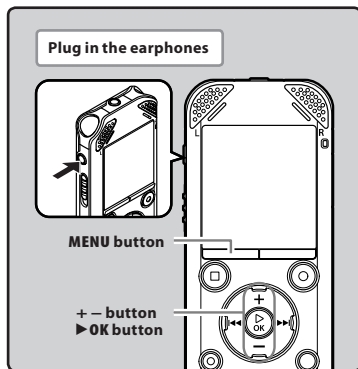

1 Set to [FM Radio] mode (☞ P.25).

2 Press the MENU button.

- The menu appears on the display (☞ P.53)



3 Press the ▶ OK button to move the cursor to the item you want to set.



4 Press the + or – button to select [Auto-preset].



5 Press the ▶ OK button.

- [Auto-preset] appears on the display.

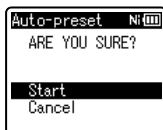

- Select [Cancel] and press the ▶ OK button to return to the previous display.

6 Press the ▶ OK button again.

- [Scanning] appears on the display and scanning starts. When [Preset completed] appears, the scan is complete.

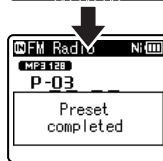
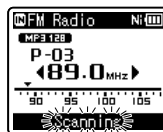

Note

- The preset numbers are automatically assigned according to the frequency.

Changing the reception mode

It is possible to fine tune the channels manually if the station you are looking for has a weak signal and couldn't be detected using the Auto Preset function.

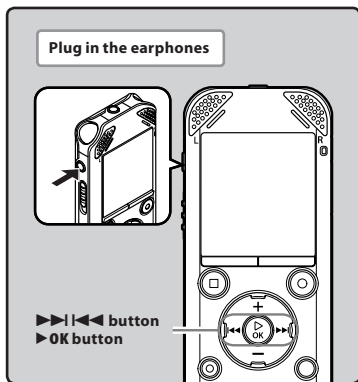

1 Perform Steps 1 through 3 from "FM radio mode operations" (P.48).

2 Press the ▶OK button to select a reception mode.

- If you have preset stations, the reception mode changes at each press of the ▶OK button.

Preset call mode

- Press the ▶▶ or ◀◀ button to select a preset station.
 (a) Preset number

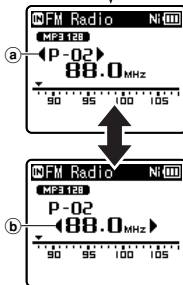

Auto/Manual mode

- Press the ▶▶ or ◀◀ button to adjust the frequency and tune to a radio signal (Manual reception).
- Press and hold the ▶▶ or ◀◀ button to scan through the receivable radio stations (Auto reception).
 (b) Tuning frequency
- If you press the ▶OK button while a frequency that you have not preset is being received, the recorder will tune in to the station whose preset number is closest to the frequency that was being received.

Adding a radio station

You can add radio stations from Auto/Manual reception to the preset stations.

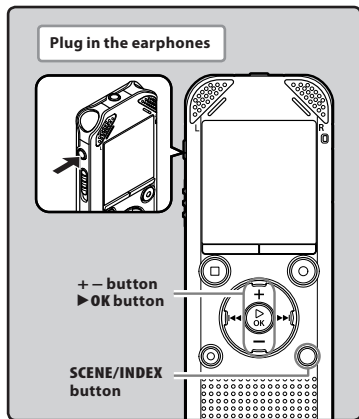

- 1 Tune to the radio station you want to preset.

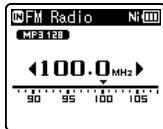

- 2 Press the SCENE/INDEX button.



- Select [Cancel] and press the ▶OK button to return to the previous display.

- 3 Press the ▶OK button.

- Up to 30 radio stations can be preset.

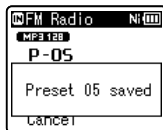

Deleting a preset radio station

- 1 Tune to the preset radio station you wish to erase.
- 2 Press the ERASE button.



- Select [Cancel] and press the ▶OK button to return to the previous display.

- 3 Press the ▶OK button.



Note

- The preset numbers are automatically assigned according to the frequency.

Recording from the FM radio

! For WS-813:

Plug in the earphones

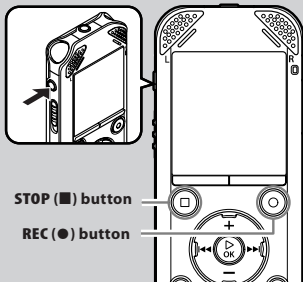

STOP (■) button

REC (●) button

4

Recording from the FM radio

1 Tune to the broadcast program you wish to record (☞ P.25, P.48).

2 In menu settings relating to FM radio, set [Output] to [Earphone] (☞ P.67).

- If [Output] is set to [Speaker], you cannot record.

3 Press the REC (●) button to start recording.

- The LED indicator light turns on and [●] appears on the display.

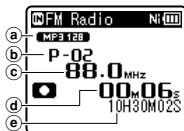

- (a) Recording mode indicator
- (b) Preset number
- (c) Tuning frequency
- (d) Elapsed recording time
- (e) Remaining recording time

When recording from the FM radio:

Even if the sound of the FM radio is clear, in certain conditions there may be cases of electric interference when the recording starts.

To avoid such a problem, perform a recording test before recording. Also, be sure to record in places with good reception.

4 Press the STOP (■) button to stop recording.

- [●] disappears and the reception display re-appears.

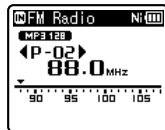

- When you record FM radio, the recording is stored automatically in the [FM Radio] folder in the [Recorder] folder.

Notes

- When recording from the FM radio, be sure to connect the earphones to the **EAR** jack.
- When FM radio is recorded, the file name assigned to the recording (☞ P.33) is appended with a date and time.

813_0001_120715_0915.WMA

Date: [120715] (2012, July 15)

Time: [0915] (9.15 am)

Menu setting

Menu setting method

Items in menus are categorized by tabs, so select a tab first and move to the desired item to set it. You can set each menu item as follows.

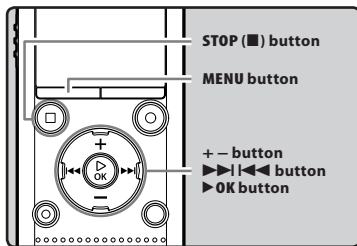

1 While the recorder is in stop mode, press the MENU button.

- The menu appears on the display.



- Menu items can be set during recording or playback.

2 Press the + or - button to move to the tab that contains the item you want to set.

- You can change the menu display by moving the settings tab cursor.



3 Press the ►OK button to move the cursor to the item you want to set.



4 Press the + or - button to move to the item you want to set.



5 Press the ►OK button.

- The display shows the setting of the selected item.

6 Press the + or - button to change the setting.

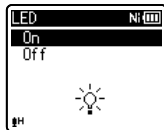

7 Press the ►OK button to complete the setting process.

- A message appears on the screen to inform you that the setting has been entered.

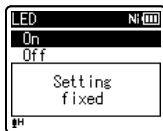

- Pressing the **◀◀** button without pressing the **▶OK** button cancels the setting process and returns you to the previous screen.

8 Press the **STOP (■)** button to close the menu screen.

- If the menu screen is open during recording or playback, pressing the **STOP (■)** button allows you to return to the recording or playback screen without interrupting recording or playback.

5

Notes

- The recorder stops if you leave it idle for 3 minutes during a menu setup operation and do not set a selected item.
- When menu settings are entered during recording or playback, the menu settings are canceled if 8 seconds elapse with no buttons being pressed.

■ Setting menu during recording:

Function	Setting
[Rec Level]	
[Zoom Mic] *1	
[Low Cut Filter]	
[VCVA]	To menu item options
[Backlight]	
[LED]	

■ Setting menu during playback:

Function	Setting
[Property]	
[Voice Playback] *2 *4	
[Noise Cancel] *4	
[Voice Balancer] *2 *4	
[Voice Filter] *3 *4	
[Play Mode]	To menu item options
[Equalizer] *5	
[Skip Space]	
[Play Scene]	
[Backlight]	
[LED]	

■ Setting menu during FM radio reception (WS-813 only):

- During recording in [FM Radio] mode, only the [Backlight] and [LED] settings are available.

Function	Setting
[Rec Mode]	
[Auto-preset]	
[Scan Level]	To menu item options
[Backlight]	
[LED]	
[Output]	

*1 WS-813 only.

*2 WS-813, WS-812 only.

*3 WS-811 only.

*4 Function active only in [Recorder] mode.

*5 Function active only in [Music] mode.

File Menu

Voice Detect



For WS-813, WS-812:

This function extracts voice portions from a recorded voice file.

See “**Extract voice portions from file [Voice Detect]**” (P.68).

File Lock

Locking a file keeps important data from being accidentally erased. Locked files are not erased when you select to erase all files from a folder (P.45).

[Lock]:

Locks the file and prevents it from being erased.

[Unlock]:

Unlocks the file and allows it to be erased.

Replace

You can move a file in a folder to change the order of playback.

See “**Rearranging files [Replace]**” (P.69).

Move/Copy



For WS-813, WS-812:

Files saved in the internal memory or the microSD card can be moved or copied within the memory.

See “**Moving/Copying files [Move/Copy]**” (P.70).

File Divide

Files with large capacities and long recording times can be divided so that they are easier to manage and edit.

See “**Dividing Files [File Divide]**” (P.72).

Property

File and folder information can be confirmed from the menu screen.

When a file is selected:

[Name] (File name), **[Date]** (Time stamp), **[Size]** (File size), **[Bit Rate]*1** (File format), **[Artist]*2** (Artist name) and **[Album]*2** (Album name) appear on the display.

*1 When a linear PCM format file has been selected, the **[Bit Rate]** area displays the sampling frequency and bit rate.

*2 When a file contains no tag information, **[UNKNOWN_ARTIST]**, **[UNKNOWN_ALBUM]** appear on the display.

When a folder is selected:

[Name] (Folder name), **[Folder]*1** (Folder number) and **[File]*2** (File number) appear on the display.

*1 When **[Recorder]** is selected, **[Folder]** does not appear on the display.

*2 Files which cannot be recognized by this recorder are not included in the number of files.

- Select a file for which you would like to verify information in advance before operating the menu.

Rec Menu

Rec Level

Recording sensitivity is adjustable to meet recording needs.

[High]: Highest recording sensitivity suitable for recording at a distance or a low volume source, such as conferences with a large number of people.

[Middle]: Suitable for recording meetings and seminars with a small number of people.

[Low]: Lowest recording sensitivity suitable for dictation.

[Manual]*:

The recording level must be adjusted manually during recording. The level can be adjusted from **[01]** to **[30]**.

* WS-813, WS-812 only.

- When you want to record a speaker's voice clearly, set **[Rec Level]** to **[Low]** and hold the recorder's built-in stereo microphone close to the speaker's mouth (5-10 cm) while recording.
- The recording level is automatically adjusted when the recording level is set to **[High]**, **[Middle]** or **[Low]**. Inputting a very loud sound may produce noise even when the recording level is set to **[High]**, **[Middle]** or **[Low]**.

■ Adjust the recording level:

 **For WS-813:**

1 Press the **▶▶|** or **|◀◀** button while the recorder is recording or paused to adjust the recording level.

- To adjust the recording level, set both **[VCVA]** and **[V-Sync. Rec]** to **[Off]**.
- The higher the number, the higher the level and the larger the indicator position on the level meter.

- When the recording level is set to **[Manual]**, the limiter function is disabled. When **[OV]** appears on the screen, it indicates that the sound being recorded is affected by distortion. Adjust the recording level so that **[OV]** is not displayed.

Rec Mode

The recorder can record in the linear PCM format (WS-813, WS-812 only). High resolution recording at a high sampling rate and high bit rate equivalent or superior to that of a music CD is possible. Moreover, the recorder also supports the MP3 and WMA formats.

1 Select the recording format.

[PCM]*: This is an uncompressed audio format which is used for music CDs etc.

[MP3]: MPEG is an international standard established by a working group of the ISO (International Organization for Standardization).

[WMA]: This is an audio compression encoding method that was developed by Microsoft Corporation in the US.

* WS-813, WS-812 only.

2 Select the recording rate.

When [PCM]*1 is selected:
[44.1 kHz/16 bit]

When [MP3] is selected:
[256 kbps]*1, [192 kbps]*2,
[128 kbps]

When [WMA] is selected:
[128 kbps], [64 kbps]
[32 kbps]*3, [16 kbps]*3, [8 kbps]*3

*1 WS-813, WS-812 only.

*2 WS-811 only.

*3 Monaural recording.

- To record a meeting or lecture clearly, set **[Rec Mode]** to a position other than **[8kbps]**.
- When an external monaural microphone is used while **[Rec Mode]** is set to a stereo recording mode, audio is recorded to the L channel only.

Zoom Mic

! For WS-813:

This function can be switched using the built-in stereo microphone from expansive stereo recording to high directivity recording.

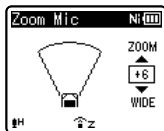

- Increasing the value narrows the directivity.
- Decreasing the value widens the directivity, enabling you to record in an expansive stereo sound.
- If you reduce the directivity and widen the recording range, the recorded sound has an expansive stereo feeling.

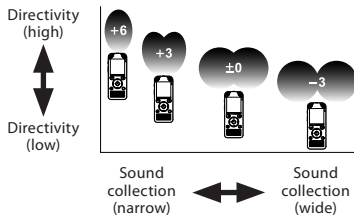
■ About the Zoom Mic function:

Low Cut Filter

The recorder has a Low Cut Filter function to minimize low-frequency sounds and record voices more clearly. This function can reduce noise from air conditioners and projectors and other similar noises.

[On]:

Enables the Low Cut Filter function.

[Off]:

Disables the Low Cut Filter function.

VCVA

When the microphone senses that sounds have reached a preset threshold volume level, the built-in Variable Control Voice Actuator (VCVA) starts recording automatically, and stops when the volume drops below the threshold level. The VCVA feature extends recording time and conserves memory by stopping recording during silent periods, which helps playback to be more efficient.

[On]:

Enables the VCVA function. Starts recording in VCVA mode.

[Off]:

Disables the VCVA function. Resumes recording in normal mode.

■ Adjust the start/stop actuation level:**1 Press the REC (●) button to start recording.**

- When the sound volume is lower than the preset threshold sound level, recording automatically stops after approximately 1 second, and **[Standby]** flashes on the display. The LED indicator light turns on when recording starts and flashes when recording pauses.

2 Press the **▶▶▶** or **◀◀◀** button to adjust the start/stop actuation level.

- The VCVA level can be set to any of 28 different values.
- The higher the value, the more sensitive the recorder is to sounds. At the highest value, even the faintest sound activates recording.

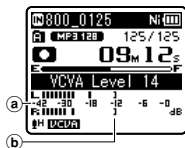

- ① Level meter (varies according to the sound volume being recorded)
- ② Start level (moves to the right/left according to the set level)

- When the [VCVA] function is being used, the following function is not available.
 - [V-Sync. Rec]
- If the start/stop actuation level is not adjusted within 2 seconds, the display returns to the previous one.
- If the surrounding noise is loud, the start/stop actuation sensitivity of the VCVA can be adjusted according to the recording conditions.
- To ensure successful recording, prior testing and adjustment of the start/stop actuation level is recommended.

V-Sync. Rec

Voice sync recording starts when a voice louder than the voice sync level (detection level) is detected. When the voice becomes low, recording automatically stops. When voice sync recording is on and the input level is equal to or below the voice sync level (detection level) for a period of at least the specified detection time, the recorder returns to the standby mode or stop mode.

When [On/Off] is selected:

[On]: Enables the Voice sync recording function.

[Off]: Disables the Voice sync recording function.

When [V-Sync. time] is selected:

[1 sec.] [2 sec.] [3 sec.] [5 sec.] [10 sec.]

When [Mode] is selected:

[One time]:

Closes the file after recording and returns to stop mode.

[Continuous]:

Closes the file after recording and returns to recording standby mode. If sound is subsequently detected, recording will start with a new file.

■ Adjust the voice sync level:

1 Press the REC (●) button to start recording.

2 Press the **▶▶▶** or **◀◀◀** button to adjust the voice sync level.

- The voice sync level can be set to any of 28 different values.
- The higher the value, the more sensitive the recorder is to sounds. At the highest value, even the faintest sound activates recording.

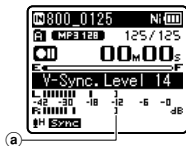

- a) Voice sync level (moves to the right/left according to the set level)

3 Press the REC (●) button again.

- The recorder goes into standby. [Standby] flashes on the display and the LED indicator light flashes.
- When the input is at or above the voice sync level, recording starts automatically.

4 Voice sync recording stops automatically.

- If sound at a volume equal to or below the voice sync level continues for the specified time, voice sync recording ends automatically, and the recorder returns to the recording standby mode or stop mode. Every time the recorder enters standby mode, the current file is closed and recording continues in a new file.
- To stop the recorder during voice sync recording, press the STOP (■) button.
- When the [V-Sync. Rec] function is being used, the following function is not available.
 - [VCVA] (P.57)

Rec Scene

The recording setting can be selected from the [Lecture], [Conference], [Meeting], [Dictation] or [DNS] templates to suit the recording conditions. You can also save a recording setting of your choice.

1 Select [Select] or [Register].

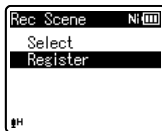

[Select]: From the templates, select a recording scene that suits the recording conditions. For details, see "Template settings" (P.60). Alternatively, select a recording scene that has been customized for a particular purpose.

[Register]: You can save up to 3 sets of menu settings relating to a current recording.

- If you select [Select], proceed to Step 4.

■ When [Register] is selected:

2 Set the recording settings according to your preferences.



3 Specify a save destination.

- You can select the save destination from [User Setting 1], [User Setting 2] and [User Setting 3].

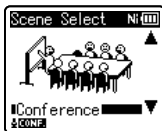
■ When [Select] is selected:**4 Select a recording scene.****Template settings:****[Lecture]:**

[Rec Level]	[High]
[Rec Mode]	[MP3]: [128 kbps]
[Zoom Mic] *	[+6]
[Low Cut Filter]	[On]
[VCVA]	[Off]
[V-Sync. Rec]	[Off]

[Conference]:

[Rec Level]	[High]
[Rec Mode]	[MP3]: [128 kbps]
[Zoom Mic] *	[Off]
[Low Cut Filter]	[On]
[VCVA]	[Off]
[V-Sync. Rec]	[Off]

[Meeting]:

[Rec Level]	[Middle]
[Rec Mode]	[MP3]: [128 kbps]
[Zoom Mic] *	[Off]
[Low Cut Filter]	[On]
[VCVA]	[Off]
[V-Sync. Rec]	[Off]

[Dictation]:

[Rec Level]	[Low]
[Rec Mode]	[WMA]: [64kbps]
[Zoom Mic] *	[Off]
[Low Cut Filter]	[On]
[VCVA]	[Off]
[V-Sync. Rec]	[Off]

[DNS]:

For Dragon Naturally Speaking
(Nuance Communications Inc.)

* WS-813 only.

- When a recording scene is selected, recording-related menu settings cannot be changed. If you wish to use these functions, set [Rec Scene] to [Off].

To check the settings:

On the [Scene Select] display, select a recording scene using the + and - buttons, and press the ►► button. Press the ◀◀ button to return to the [Scene Select] display.

▶ Play Menu

Voice Playback

! For WS-813, WS-812:

You can play back just the voice portions from a recorded audio file. Before using this function, extract the voice portions from the file (☞ P.68).

[On]:

Automatically skips silent portions of the file and plays back only the voice portions.

[Off]:

Disables the Voice Playback function.

- [Voice Playback] only works in [Recorder] mode.
- When the [Voice Playback] function is being used, the following functions are not available.
 - Change playback speed/tone (☞ P.41)
 - [Noise Cancel]

Noise Cancel

If recorded audio is unclear because of noisy surroundings, adjust the Noise Cancel setting level.

[High] [Low]: Enables the Noise Cancel function. For better sound quality, noise is reduced when the file is played back.

[Off]: Disables the Noise Cancel function.

- [Noise Cancel] only works in [Recorder] mode.
- When the [Noise Cancel] function is being used, the following functions are not available.
 - Change playback speed/tone (☞ P.41)
 - [Voice Playback]
 - [Voice Balancer]
 - [Voice Filter]

Voice Balancer

! For WS-813, WS-812 :

This function compensates for the low-volume portions of a recorded audio file, making them louder. It makes soft sounds such as conversation much more distinct. You can use this function with files saved in folders for voice recordings ([A] to [E]).

[On]:

Compensates for the low-volume portions of a voice file during playback, making them louder.

[Off]:

Disables the Voice Balancer function.

- [Voice Balancer] only works in [Recorder] mode.
- When the [Voice Balancer] function is being used, the following functions are not available.
 - [Noise Cancel]

Voice Filter

! For WS-811:

The recorder has a Voice Filter Function to cut low and high frequency tones during normal, fast, or slow playback, and enable clear audio playback.

[On]:

Enables the Voice Filter function.

[Off]:

Disables the Voice Filter function.

- [Voice Filter] only works in [Recorder] mode.
- When the [Voice Filter] function is being used, the following function is not available.
 - [Noise Cancel]

Play Mode

You can select the playback mode that best suits the type of audio.

■ **When the recorder is in [Recorder] mode:**

1 Select [File] or [Folder].

[File]:

Stop after playing back the current file.

[Folder]:

Continuously play files in the current folder until the last file and then stop.

■ **When the recorder is in [Music] mode:**

Select the desired playback range:

1 Select [Playback range].

2 Select [File], [Folder] or [All].

[File]:

Selects the current file.

[Folder]:

Selects the current folder.

[All]:

Selects all files currently in memory.

Select the desired playback mode:

1 Select [Repeat] or [Random].

[Repeat]:

Sets to repeat playback mode.

[Random]:

Sets to random playback mode.

2 Select [On] or [Off].

[On]: Sets the playback range to be played back repeatedly or randomly.

[Off]: Disables the playback mode function.

- In **[File]** mode, when the recorder comes to the end of the last file in the folder, **[End]** flashes for two seconds on the display and the recorder stops at the start of the last file.

- In **[Folder]** mode, when the recorder comes to the end of the last file in the folder, **[End]** flashes for two seconds on the display and the recorder stops at the start of the first file in the folder.
- In **[All]** mode, after playing the last file in the current folder, the recorder starts playing from the first file in the next folder. When it comes to the end of the last file in the recorder, **[End]** flashes for two seconds on the display and the recorder stops at the start of the first file in the recorder.

Equalizer

When listening to music, you can set your favorite sound quality by adjusting the equalizer setting.

1 Select the desired equalizer characteristics.

[Off]: Disables the equalizer function.

[Rock] [Pop] [Jazz]: Enables the equalizer function.

[User]: Select **[User]** to save your own custom equalizer settings. If **[User]** is selected, proceed to Step 2.

2 Select the frequency band.

[60 Hz] [250 Hz] [1 kHz] [4 kHz] [12 kHz]:

Select the frequency bandwidth setting.

3 Select the equalizer level.

- You can select the equalizer level from **[-6]** to **[+6]** in 1dB increments.
- The higher the decibel value, the louder the sound.
- To change the settings again, press the **▶▶** or **◀◀** button and repeat the procedure from step 2.
- **[Equalizer]** only works in **[Music]** mode.

Skip Space

This function enables you to skip (forward) or reverse skip (rewind) a small portion of the file being played. This function is convenient for quickly skipping to another playback position or repeatedly playing back short phrases.

1 Select [Forward Skip] or [Reverse Skip].

2 Set the skip space.

When **[Forward Skip]** is selected:

[File Skip] [10 sec. Skip]
 [30 sec. Skip] [1min. Skip]
 [5min. Skip] [10min. Skip]

When **[Reverse Skip]** is selected:

[File Skip] [1 sec. Skip] – [5 sec. Skip]
 [10 sec. Skip] [30 sec. Skip]
 [1 min. Skip] [5 min. Skip]
 [10 min. Skip]

Forward/Reverse Skip Playback:

1 Press the ► OK button to start playback.

2 Press the ►► or ◀◀ button.

- The recorder skips (forward) or reverse skips (rewind) a set space and starts playing back.
- If there is an index mark/temp mark or a cue closer than the skip space, the recorder forward skips/reverse skips to that position.

Play Scene

Voice files recorded in the recorder and music files downloaded from a PC can be saved with the playback settings of your choice to suit the different sound qualities and playback methods.

1 Select [Select] or [Register].



[Select]:

Select a playback scene customized to suit your preferences.

[Register]:

You can save up to 5 sets of menu settings relating to a current playback.

- If you select **[Select]**, proceed to Step 4.

When [Register] is selected:

2 Set the playback settings according to your preferences.

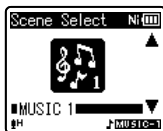

3 Specify a save destination for the settings.

- You can select the save destination from among [VOICE 1] to [MUSIC 3].

■ When [Select] is selected:

4 Select a playback scene.



To check the settings:

On the [Scene Select] display, select a playback scene using the + and - buttons, and press the ►►| button. Press the |◀◀ button to return to the [Scene Select] display.

☑ LCD/Sound Menu

Backlight

The display will remain lit for about 10 (Initial setting) seconds when a button on the recorder is pressed.

[Off]:

Disables the Backlight function.

[5 sec.] [10 sec.] [30 sec.] [1 min.]:

Enables the Backlight function.

Contrast

Display contrast can be adjusted in 12 levels.

- You can adjust the LCD display contrast level from [01] to [12].

LED

You can set the recorder so the LED indicator light does not turn on.

[On]:

Enables the LED light function.

[Off]:

Disables the LED light function.

Beep

The recorder beeps to alert you to button operations or warn you of errors. System sounds may be turned off.

[On]:

Enables the Beep function.

[Off]:

Disables the Beep function.

Language(Lang)

You can select the display language for this recorder.

[English] [Deutsch] [Français] [Español]
[Italiano] [Polski] [Русский]

- The selectable languages differ depending on the region.

Speaker

You can use the built-in speaker when the earphones are unplugged.

[On]:

Output sound from the built-in speaker.
If the earphones are plugged in, sound is not output from the built-in speaker.

[Off]:

Do not output sound from the built-in speaker.



- a** Speaker muting indicator (Appears when [Speaker] is set to [Off].)

WS-813 only:

- This is a different function from [Output] in [FM Menu]. Irrespective of the [Speaker] setting, if you have set [Output] to [Speaker] when listening to the FM radio, sound from the radio is still output from the speaker (P.67).

Device Menu

Memory Select

When a microSD card is inserted, you can select to record to either the internal memory or to the microSD card (P.23).

[Internal memory]: Internal memory.

[microSD card]: microSD card.

Power Save

If you forget to turn off power to the recorder, it is turned off automatically. If the recorder remains in stop mode for over 10 minutes (Initial setting) while the power is turned on, the power will be turned off.

[5 min.] [10 min.] [30 min.] [1 hr.]:

Set the length of time that is to elapse before the power is turned off.

[Off]: Disables the Power Save function.

- If any button is pressed, the elapsed time count before the power turns off starts over again.

Battery

Select the battery type to match the battery you are using.

[Ni-MH] (Ni (Full)):

Select when using the Olympus Ni-MH rechargeable battery (BR404).

[Alkaline] (Al (Full)):

Select when using an alkaline battery.

Time & Date

Setting the time and date beforehand enables easier file management. See “**Setting the time and date [Time & Date]**” (P.21).

USB Settings

You can switch the USB class according to your usage.

See “**Changing the USB class [USB Settings]**” (P.73).

Reset Settings

This function returns all other functions to their initial settings (factory default).

[Start]:

Returns the settings to their initial values.

[Cancel]:

Takes you back to **[Device Menu]**.

- After the settings have been returned to their initial values, the time settings and file numbers are preserved, without being returned to their initial settings.

Menu settings after resetting (initial settings):

Rec Menu:

[Rec Level]	[Middle]
[Rec Mode]	
[WMA]	[128kbps]
[Zoom Mic]*1	[Off]
[Low Cut Filter]	[Off]
[VCVA]	[Off]
[V-Sync. Rec]	
[On/Off]	[Off]
[V-Sync. time]	[1 sec.]
[Mode]	[Continuous]
[Rec Scene]	[Off]

Play Menu:

[Voice Playback] *2 *4	[On]
[Noise Cancel]*4	[Off]
[Voice Balancer] *2 *4	[Off]
[Voice Filter] *3 *4	[Off]
[Play Mode] *4	[File]

[Play Mode]*5

[Playback range]	[Folder]
[Repeat]	[Off]
[Random]	[Off]
[Equalizer]*5	[Off]
[Skip Space]	
[Forward Skip]	[File Skip]
[Reverse Skip]	[File Skip]
[Play Scene]	[Off]

LCD/Sound Menu:

[Backlight]	[10 sec.]
[Contrast]	[Level 06]
[LED]	[On]
[Beep]	[On]
[Language(Lang)]	[English]
[Speaker]	[On]

Device Menu:

[Memory Select]	[Internal memory]
[Power Save]	[10 min.]
[Battery]	[Ni-MH]*2 [Alkaline]*3
[USB Settings]	
[USB Connection]	[PC]
[USB Class]	[Storage Class]

FM Menu (WS-813 only):

[Rec Mode]	[WMA]
[Scan Level]	[High]
[Output]	[Earphone]

*1 WS-813 only.

*2 WS-813, WS-812 only.

*3 WS-811 only.

*4 Function active only in **[Recorder]** mode.

*5 Function active only in **[Music]** mode.

Format

When the recorder is formatted, all the saved data, including locked files and read-only files, are erased.

See “**Formatting the recorder [Format]**” (P.74).

Memory Info.

The recordable capacity remaining and overall capacity of the recording media can be seen from the menu.

- The recorder uses some of its memory capacity to maintain a management file. For a microSD card, the indicated remaining capacity is less than the total capacity of the card due to characteristics of the microSD card, but this is not a malfunction.

System Info.

You can check information about the recorder on the menu screen. **[Model]** (Model Name), **[Version]** (System version) and **[Serial No.]** (Serial Number) appear on the display.

FM Menu



For WS-813:

Can be operated only in **[FM Radio]** mode.

Rec Mode

You can change the recording mode when recording from the FM radio. Select a recording mode to suit your purpose.

[PCM]:

The recording rate is automatically set to **[44.1kHz/16bit]**.

[MP3]:

The recording rate is automatically set to **[128kbps]**.

[WMA]:

The recording rate is automatically set to **[128kbps]**.

Auto-preset

Automatically adds receivable radio stations to the presets.

See **"Presetting radio stations automatically [Auto-preset]"** (P.49).

Scan Level

You can change the scan sensitivity when scanning for radio stations with auto preset. Select the sensitivity to suit the reception conditions.

[High]:

Receive radio station signals using high sensitivity. You should normally select this setting.

[Low]:

Receive radio station signals using reduced sensitivity. Try this setting when signals from unwanted stations are causing interference.

Output

You can change the audio output of the FM radio.

[Earphone]:

Output sound from the earphones. Sound is not output from the built-in speaker even if you unplug the earphones.

[Speaker]:

Always output sound from the built-in speaker. Sound is not output from the earphones even if you plug them in.

- This is a different function from **[Speaker]** in **[LCD/Sound Menu]**. Irrespective of the **[Speaker]** setting, if you have set **[Output]** to **[Speaker]** when listening to the FM radio, sound from the radio is still output from the speaker (P.65).

Extract voice portions from file [Voice Detect]

This function extracts voice portions from a recorded voice file. During playback of the file following extraction, the silent portions are automatically skipped.

- The voice extraction function can be operated only in [Recorder] mode.

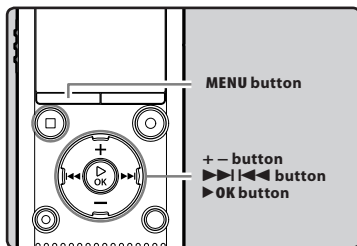

5

Menu setting method

- Select a folder that contains the file from which you want to extract the voice portions (see P.28).
- Select [Voice Detect] from the menu on the [File Menu].
 - For details on how to enter the menu settings, see "Menu setting method" (see P.53).
- Press the + or – button to select the file from which you want to extract the voice portions.

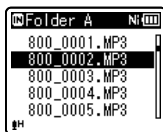

- Press the ▶OK button.

- Extraction of voice portions starts. During the process, the progress status is shown as a percentage on the display.
- The process is completed when [Voice Detection completed] is displayed.

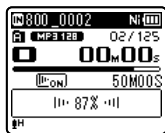

Notes

- When extraction of voice portions ends, the [Voice Playback] setting in the [Play Menu] switches ON.
- If you have selected a folder that does not contain the processed file, [Select a file] appears on the display. Select the folder in which the file has been saved and then perform the process again.
- Voice portions may not be extracted properly from a file in which you have recorded the sound of musical instruments playing or similar sounds.
- Voice portions may not be properly extracted if the voice level was low (the level meter in under -12 dB) and/or the ambient noise was high at the time of the recording.
- The larger a recorded voice file, the more time extraction processing will take. Before starting extraction, charge the battery or replace it with a new one in order to ensure that the battery does not go flat during processing.

Rearranging files [Replace]

You can move a file in a folder to change the order of playback. First select the folder (file) for which you want to change the playback order.

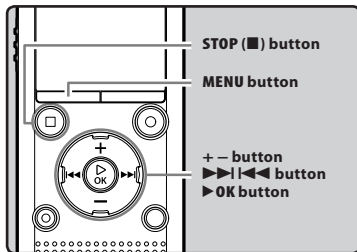

- 1 Select the folder for which you want to rearrange the file order (see P.28).
- 2 Select [Replace] from the menu on the [File Menu].
 - For details on how to enter the menu settings, see "Menu setting method" (see P.53).
- 3 Press the + or – button to select the file you want to move.

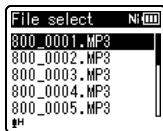

- 4 Press the ▶OK button.
 - The cursor will flash to confirm that the file can be moved.

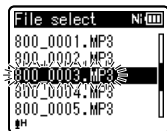

- 5 Press the + or – button to select the location to which you want to move the file.

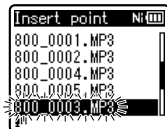

- 6 Press the ▶OK button to complete the setting.
 - If you want to move more files, repeat Steps 3 through 6.
 - Pressing the ◀◀ button without pressing the ▶OK button cancels the setting process and returns you to the previous screen.
- 7 Press the STOP (■) button to close the menu setting.

Moving/Copying files [Move/Copy]

Files saved in the internal memory or a microSD card can be moved or copied within the memory. Files can also be moved or copied between memory.

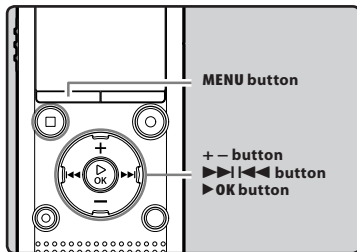

5

Menu setting method

- 1 Select the folder where the file you want to move or copy is saved (☞ P.28).
- 2 Select **[Move/Copy]** from the menu on the **[File Menu]**.
 - For details on how to enter the menu settings, see "Menu setting method" (☞ P.53).
- 3 Press the **+** or **-** button to select the location to which you want to move or copy the file.

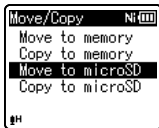

[Move to memory]:

Move a file from the internal memory or microSD card to another folder within the internal memory.

[Copy to memory]:

Copy a file from the internal memory or microSD card to another folder within the internal memory.

[Move to microSD]:

Move a file from the internal memory or microSD card to another folder in the microSD card.

[Copy to microSD]:

Copy a file from the internal memory or microSD card to another folder in the microSD card.

- 4 Press the **▶ OK** button.
- 5 Press the **+** or **-** button to select the number of files you want to move or copy.

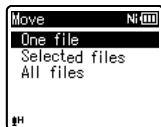

[One file]:

Select only the specified file.

[Selected files]:

Select multiple files.

[All files]:

Select all files in the folder.

- 6 Press the **▶ OK** button to move to the respective setting.

When you select [One file]:

- 1 Press the + or – button to select the file you want to move or copy.
- 2 Press the ►OK button to select the file.

When you select [Selected files]:

- 1 Press the + or – button to select the file(s) you want to move or copy.
- 2 Press the ►►I button to check the file(s) selected.

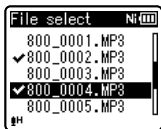

- 3 Repeat steps ① and ② until all the files you want to move/copy are selected, then press the ►OK button.

When you select [All files]:

When you select [**All files**], all the files in the folder are automatically selected and the recorder moves to the [**Destination**] screen.

- 7 Press the ►►I, I◀◀ or +, – button to select the folder to which you want to move or copy the file.



- 8 Press the ►OK button.

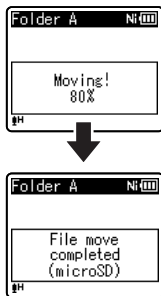

- File move or file copy starts if [**Moving!**] or [**Copying!**] appears on the display. During the process, the progress status is shown as a percentage. The process is completed when [**File move completed**] or [**File copy completed**] is displayed.

Notes

- The recorder cannot copy when the memory capacity is not sufficient.
- The recorder cannot move or copy when the number of files exceeds 200.
- Do not remove the battery during moving or copying. Doing so may damage the data.
- A file cannot be moved or copied to the same folder.
- When operation is canceled during moving or copying, only the files for which the move or copy process has already been completed are saved at the new location. The move or copy process is canceled for all other files.
- Files which are locked remain so even after they are moved or copied.
- DRM files cannot be moved or copied.
- Files cannot be moved or copied directly under the [**Recorder**] folder.

Dividing files [File Divide]

Files with large capacities and long recording times can be divided so that they are easier to manage and edit.

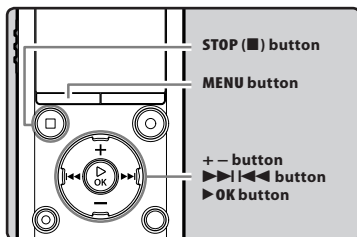

5

Menu setting method



Only MP3 files and PCM* files recorded on this recorder can be divided.

* WS-813, WS-812 only.

1 Stop playback at the divide position.

- While the recorder is in playback mode, press and hold the ►► or ◀◀ button to fast-forward or rewind.
- It is useful to mark the divide position in advance by setting an index mark.

2 Select [File Divide] from the menu on the [File Menu].

- For details on how to enter the menu settings, see "Menu setting method" (P.53).



3 Press the + button to select [Start].



4 Press the ►OK button.

- [Dividing!] appears and file dividing starts.
- File dividing is completed when [File divide completed] appears.

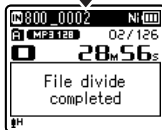
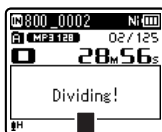

5 Press the STOP (■) button to close the menu screen.

Notes

- File dividing can be performed only when the file list is displayed.
- The recorder cannot divide files when the number of files in the folder exceeds 199.
- Locked files cannot be divided (P.55).
- After the file is split, the front part of the file is renamed [File name_1.MP3] and the latter part of the file is named [File name_2.MP3].

- If a file has an extremely short recording time, it may not be divided even if it is an MP3 file or PCM file.
- Do not remove the battery while dividing a file. Doing so may damage the data.

Changing the USB class [USB Settings]

Besides selecting [PC] (Connect to PC to transfer files) or [AC Adapter] (Connect to AC adapter to recharge the battery), you can switch the USB class to suit your usage.

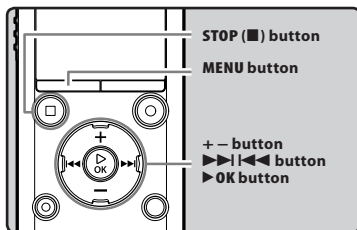

1 Select [USB Settings] from the menu on the [Device Menu].

- For details on how to enter the menu settings, see "Menu setting method" (P.53).

2 Press the + or – button to select [USB Connection] or [USB Class].



[USB Connection]:
Setting for connecting to a PC.

[USB Class]:
Setting for USB class.

3 Press the ► OK button.

4 Press the + or – button to change the setting.

When [USB Connection] is selected:



[PC]: Setting for when the recorder is connected to a PC and used as a storage device or composite device. Connected as storage or composite.

[AC Adapter]: Setting for when the recorder is connected to a PC for charging or to the AC Adapter (A514) (optional).

[Optional]: Setting to confirm the connection method each time a USB connection is made.

When [USB Class] is selected:



[Storage Class]: Recognized by a PC as an external memory device.

[Composite]: Setting when connected to a PC and used as an external memory device, USB speaker or microphone.

5 Press the ► OK button to complete the setting.

6 Press the STOP button to close the menu screen.

Notes

- When you first connect the recorder to your PC as an external storage device, the driver for the recorder will be automatically installed in your PC.
- The PC cannot recognize that the recorder is connected to the PC if [USB Connection] is set to [AC Adapter].
- If the recorder is not recognized by the PC as an external storage device, change the [USB Class] setting to [Storage Class].

Formatting the recorder [Format]

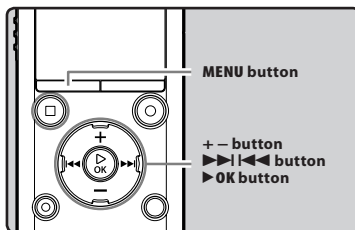

If you format the recorder, all files will be erased and all function settings will return to the defaults except the date and time settings. Transfer any important files to a computer before formatting the recorder.

1 Select [Format] from the menu on the [Device Menu].

- For details on how to enter the menu settings, see "Menu setting method" (P.53).

2 Press the + or – button to select the recording media to format.



3 Press the ▶OK button.

- 4 Press the + button to select [Start].

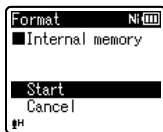

- 5 Press the ► OK button.

- After the [All data will be erased] message displays for two seconds, [Start] and [Cancel] appear.

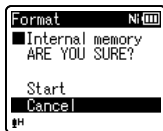
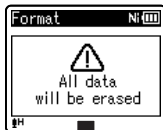

- 6 Press the + button again to select [Start].

- 7 Press the ► OK button.

- Formatting begins and [Formatting!] flashes on the display.

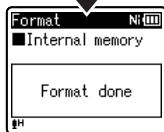

- [Format done] appears when formatting ends.

Notes

- Never format the recorder from a PC.
- When the recorder is formatted, all the saved data, including locked files and read-only files, is erased.
- After formatting, recorded voice file names may start from [0001].
- To restore the function's settings to their initial values, use [Reset Settings] (P.66).

- When a microSD card is inserted into the recorder, be sure to confirm the recording media as either [**Internal memory**] or [**microSD card**] so that there is no mistake (☞ P.65).
- Replace the battery with a new one in order to ensure that the battery does not go flat during processing. In addition, it may take over 10 seconds to complete processing. Never perform operations such as the following during processing, as such operations may damage the data.
 - ① Disconnect the AC Adapter during processing.
 - ② Remove the battery during processing.
 - ③ Remove the microSD card during processing when [**microSD card**] is selected as the recording media.
- Formatting on the recorder is Quick Format. If you format the microSD card, file management information is refreshed and the data inside the microSD card is not deleted completely. When giving someone or disposing of the microSD card, be careful of data leakage from the microSD card. We recommend that the microSD card be destroyed when you dispose of the microSD card.

Using the recorder on your PC

When connected to a PC, the recorder enables you to do the following:

- You can transfer files recorded with this recorder to a computer, play them back, and manage them by using Windows Media Player or iTunes.
- The recorder is compatible with WMA, MP3 and WAV* language content.
* WS-813, WS-812 only.
- In addition to its uses as a voice recorder and a music player, this recorder can also be used as external memory for a computer by storing data from a computer and reading it back out (see P.82).

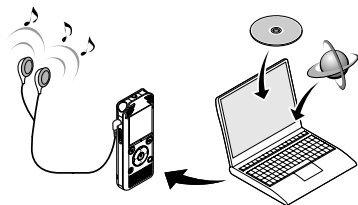

Operating environment

Windows

Operating System:

Microsoft Windows XP/Vista/7 (Standard Installation)

Compatible PC's:

Windows PC's equipped with more than one free USB port

Macintosh

Operating System:

Mac OS X 10.4.11 - 10.7 (Standard Installation)

Compatible PC's:

Apple Macintosh series equipped with more than one free USB port

Notes

- This is the operating environment required for saving files recorded by this recorder to your PC via the USB connection.
- The support service does not cover you if your PC has been updated from Windows 95/98/Me/2000 to Windows XP/Vista/7.
- Any failure on a self-modified PC will not be covered under the operational warranty.

Precautions on using the recorder connected to a PC

- When you are downloading a file from the recorder or uploading a file to the recorder, do not remove the USB cable even if the screen is indicating you can. Data is still being transferred while the LED indicator light is blinking. When removing the USB cable, be sure to follow the description in [P.80](#). If the USB cable is removed before the drive is stopped, data may not be successfully transferred.
- On a PC, do not format the drive of the recorder. Initialization is not successfully achieved on a PC. For initialization, follow the instructions in the **[Format]** display of the recorder ([P.74](#)).
- Folder (directory) names that appear in file management tools such as Explorer in Microsoft Windows and Finder in Macintosh are different from the folder names that can be set with the recorder.
- If folders or files stored on the recorder are moved or renamed by using a file management tool in Windows or Macintosh, the order of files may change or files may become unrecognizable.
- Data can be written or uploaded to the recorder even though the attribute of the recorder drive is shown as Read-only by the operating system of the PC.
- As noise may cause adverse effects on electronics devices near the recorder, unplug the external microphone and earphones when you connect the recorder to a PC.

Connecting to your PC

- 1 **Boot the PC.**
- 2 **Slide the USB connector slide lever in the direction indicated by the arrow so that the USB connector protrudes from the recorder.**

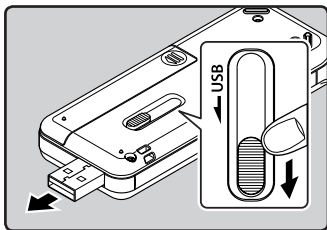

- 3 **Make sure that the recorder is in stop mode, and connect to the PC's USB port.**

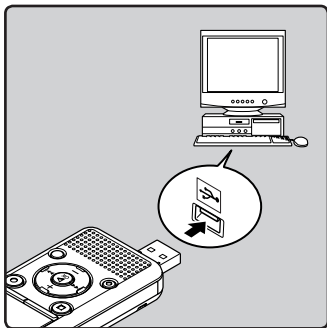

- **[Remote (Storage)]** is displayed on the recorder if the USB connector is connected.

- The recorder does not establish a connection with a PC if **[AC Adapter]** is selected in the USB connection setting. Select **[PC]** in the USB connection setting (P.73).

Windows:

When you connect the recorder to Windows and open **[My Computer]**, it is recognized by the drive name of the product. Inserting a microSD card will allow you to use it as **[Removable Disk]**.

Macintosh:

When you connect the recorder to Mac OS, it is recognized by the drive name of the product on the desktop. If a microSD card is inserted, **[Untitled]** is displayed.

Notes

- Before connecting via USB, exit HOLD mode.
- Refer to the user's manual for your PC regarding the USB port on your PC.
- Be sure to push the cable connector all the way in. Otherwise, the recorder may not operate properly.
- When the recorder is connected through a USB hub, operation may become unstable. In such cases, refrain from using a USB hub.
- Use the dedicated USB cable. If any other company's cable is used, it may lead to malfunction of the recorder. Also, never use this dedicated cable with any other company's products.

Disconnecting from your PC

Windows

- 1 Click [] on the task bar located at the lower-right corner of the screen. Click [Safely remove USB Mass Storage Device].



- The drive letter will differ depending on the PC being used.
- When the window indicating that it is safe to remove hardware appears, close the window.

- 2 Confirm that the recorder LED indicator light has turned off before disconnecting the USB cable.

Macintosh

- 1 Drag and drop the recorder's drive icon on the desktop to the Recycle Bin icon.



- 2 Confirm that the recorder LED indicator light has turned off before disconnecting the USB cable.

Note

- NEVER disconnect the USB while the LED indicator light is flashing. If you do, the data may be destroyed.

Transfer voice files to your PC

The 5 voice folders of this recorder are named **[Folder A]**, **[Folder B]**, **[Folder C]**, **[Folder D]** and **[Folder E]**. Recorded voice files are saved in these folders (On the WS-813, FM radio recordings are saved in **[FLD_FM*2]**).

Windows

- 1 **Connect the recorder to your PC** (P.79).
- 2 **Open the Explorer window.**
 - When you connect the recorder to Windows and open **[My Computer]**, it is recognized by the drive name of the product.
If you insert a microSD card, it is recognized **[Removable Disk]**.
- 3 **Open the product name folder.**
- 4 **Copy the data.**
- 5 **Disconnect the recorder from the PC** (P.80).

Macintosh

- 1 **Connect the recorder to your PC** (P.79).
 - When you connect the recorder to Mac OS, it is recognized by the drive name of the product on the desktop. If a microSD card is inserted, **[Untitled]** is displayed.
- 2 **Double-click the product name icon on the desktop.**
- 3 **Copy the data.**
- 4 **Disconnect the recorder from the PC** (P.80).

- **Drive names and folder names when a PC is connected:**

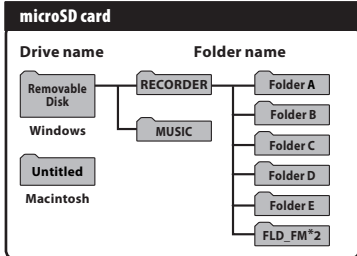
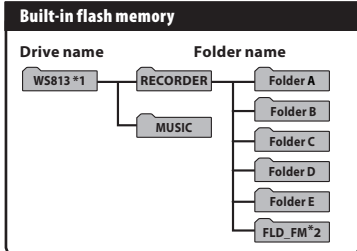

*1 Recognized by the drive name of the product.

*2 WS-813 only

Notes

- While data is being transmitted, **[Busy]** is displayed and the LED indicator light flashes. NEVER disconnect the USB while the LED indicator light is flashing. If you do, the data may be destroyed.
- WMA format files cannot be played back in the Mac OS operating environment.

Usage as external memory of the PC

In addition to its uses as a voice recorder and a music player, this recorder can also be used as external memory for a computer by storing data from a computer and reading it back out. With the recorder connected to your PC, you can download data from the memory to your PC and upload data stored on your PC to the memory.

Windows

- 1 **Connect the recorder to your PC** (P.79).
- 2 **Open the Explorer window.**
 - When you open [My Computer], the recorder is recognized by the drive name of the product.
- 3 **Open the product name folder.**
- 4 **Copy the data.**
- 5 **Disconnect the recorder from the PC** (P.80).

Macintosh

- 1 **Connect the recorder to your PC** (P.79).
 - When you connect the recorder to Mac OS, it is recognized by the drive name of the product on the desktop.
- 2 **Double-click the product name icon on the desktop.**
- 3 **Copy the data.**
- 4 **Disconnect the recorder from the PC** (P.80).

6

Note

- While data is being transmitted, [Busy] is displayed and the LED indicator light flashes. NEVER disconnect the USB while the LED indicator light is flashing. If you do, the data may be destroyed.

Other information

Alarm message list

Message	Meaning	Explanation	Action
[Battery low]	Low battery power.	Battery power is getting low.	Charge the battery (WS-813, WS-812 only) or replace with a new battery (☞ P.14, P.16).
[File locked]	Erase-locked.	Tried to delete a locked file.	Unlock the file (☞ P.55).
[Cannot record in this folder]	Not an audio recording folder.	Recording has been attempted with a [Music] folder.	Select a folder from among [F1] to [F6] and try to record again (☞ P.25, P.28).
	WS-813 only:		
	Not an audio recording folder.	Tried to record in the [FM Radio] folder.	Re-select from [Folder A] through [Folder E] and record.
[No more can be set]	Index full.	The file is full of index marks (maximum of 99 marks).	Erase unnecessary index marks (☞ P.42).
	Temp mark full.	The file is full of Temp marks (maximum of 99 marks).	Erase unnecessary Temp marks (☞ P.42).
[Folder full]	Folder full.	The folder is full of files (maximum of 200 files).	Erase unnecessary files (☞ P.45).
[Memory error]	Error in the memory.	Error in the memory.	This is a malfunction, so go to the store where you purchased the recorder or an Olympus service station for repair (☞ P.94).
[Card error]	Error in the memory.	microSD card is not recognized correctly.	Remove the microSD card and insert it again (☞ P.23 to P.24).
[Illegally copied file]	Illegally copied file.	The music file was copied illegally.	Erase the file (☞ P.45).

Message	Meaning	Explanation	Action
[Memory full]	Zero remaining memory.	No remaining memory.	Erase unnecessary files (☞ P.45).
[No file]	No file.	No files were found in the folder.	Select another folder (☞ P.26 to P.28).
[Format error]	Formatting error.	There was an error while formatting the recorder's memory.	Reformat the memory (☞ P.74).
[Can't create the system file. Connect to PC and erase unnecessary file]	The management file cannot be created.	The file for management cannot be created due to a shortage of remaining memory.	Connect the recorder to a computer and delete unnecessary files.
[Cannot play this file]	File cannot be played.	Incompatible format.	Confirm which files can be played on this recorder (☞ P.39).
[Select a file]	Unselected File.	File is not selected.	Please select a file then carry out the operation (☞ P.26 to P.28).
[Same folder. Can't be moved (copied)]	Folder cannot be moved (copied).	Attempting to move (copy) into the same folder.	Select another folder.
[Some files can't be moved (copied)]	File cannot be moved (copied).	Attempting to move (copy) a file to destination folder in which a file with the same file name exists.	Select another file.
[This file can't be divided]	File cannot be split.	Attempting to split a file other than an MP3 or PCM file recorded by this recorder.	Select another file.

Troubleshooting

Symptom	Probable cause	Action
Nothing appears on the display	The battery is not loaded properly.	Verify that the battery polarities ⊕ and ⊖ are correct (☞ P.14).
	Battery power is getting low.	Charge the battery (WS-813, WS-812 only) or replace with a new battery (☞ P.14, P.16).
	The power is off.	Turn the power on (☞ P.19).
Won't start	Battery power is getting low.	Charge the battery (WS-813, WS-812 only) or replace with a new battery (☞ P.14, P.16).
	The power is off.	Turn the power on (☞ P.19).
	The recorder is in HOLD mode.	Release the recorder from HOLD (☞ P.20).
Unable to record	Low remaining memory.	Erase unnecessary files (☞ P.45).
	The maximum number of files has been reached.	Change to another folder (☞ P.26 to P.28).
	WS-813 only:	
	[Output] in the [FM Radio] settings is set to [Speaker].	Set [Output] to [Earphone] (☞ P.67).
No playback sound heard	The earphones are connected.	Unplug the earphones to use the built-in speaker.
	[Speaker] is set to [Off].	To output from the built-in speaker, set [Speaker] to [On] (☞ P.65).
	The volume level is set to [00].	Adjust the volume level (☞ P.36).
Recording level too low	The microphone sensitivity is too low.	Set [Rec Level] to [High] or [Middle] (☞ P.56).
	This could potentially be because the output level for the connected external devices is too low.	Adjust the output level for the connected devices.
	WS-813 only:	
	The recording level has not been adjusted.	Adjust the recording level and then try recording once more (☞ P.56).

Symptom	Probable cause	Action
Recording level too high	WS-813 only:	
	The recording level has not been adjusted.	Adjust the recording level and then try recording once more (☞ P.56).
	This could potentially be because the recording level and output level for connected external devices is too high.	If you cannot record clearly even after adjusting the recording level, then adjust the output level for the connected devices (☞ P.56).
Voice files are not recorded in stereo	The connected external microphone is monaural.	When an external monaural microphone is connected for recording audio, audio is recorded to the L channel only.
	[Rec Mode] is set to a monaural recording mode.	Set [Rec Mode] to the stereo recording mode (☞ P.56).
	WS-813 only:	
	[Zoom Mic] is set to the + side.	Set [Zoom Mic] to [Off] (☞ P.57).
Cannot find the recorded Voice File	Wrong folder.	Switch to the correct folder (☞ P.26 to P.28).
Noise heard during playback	The recorder was shaken during recording.	
	The recorder was placed near a cell phone or fluorescent lamp while recording or during playback.	Move the recorder.
Silent portions not skipped during playback	WS-813, WS-812 only:	
	The [Voice Detect] process has not been performed.	Extract voice portions using [Voice Detect].
	[Voice Playback] is set to [Off].	Set [Voice Playback] to [On].
Unable to erase the file	The file is locked.	Unlock the file (☞ P.55).
	The file is read-only.	Unlock the file or cancel the file's read-only setting on the PC.
Unable to erase the folder	The folder contains a file which cannot be recognized by the recorder.	Connect the recorder to your PC and erase the folder (☞ P.79).

Symptom	Probable cause	Action
Noise is audible through the recording monitor	Acoustic feedback is occurring.	If the built-in speaker amps are used to monitor recording, there is a risk that audio feedback will occur while recording. It is recommended that you use earphones as the recording monitor.
		Make adjustments, such as further distancing the earphones from the microphones, not pointing the microphones at the earphones, or lowering the volume of the recording monitor.
Unable to set index marks, temp marks	The maximum number of marks has been reached.	Erase unnecessary marks (☞ P.42).
	The file is locked.	Unlock the file (☞ P.55).
	The file is read-only.	Unlock the file or cancel the file's read-only setting on the PC.
Cannot receive FM radio signal	WS-813 only:	
	The earphones are not plugged into the EAR jack. [Output] is set to [Earphone] .	The supplied earphones also function as an antenna. When using the recorder as a radio, be sure to plug in the earphones. To output from the built-in speaker, set [Output] to [Speaker] (☞ P.67).
Cannot recharge	WS-813, WS-812 only:	
	[Battery] is set to [Alkaline] .	When using the supplied rechargeable battery, set the battery setting to [Ni-MH] . Also, avoid using the battery outside the recommended temperature range (☞ P.15, P.18, P.65).
	You have not pressed the ► OK button. [USB Class] is set to [Composite] .	When using the USB connection, follow the confirmation display and press the ► OK button. Set [USB Class] to [Storage Class] (☞ P.73).
The PC is unable to recognize the recorder	[USB Connection] is set to [AC Adapter] .	Set [USB Connection] to [PC] (☞ P.73).

Accessories (optional)

Accessories exclusive to the Olympus voice recorder can be purchased directly from Online Shop on our company's website. Availability of accessories differs depending on the country.

- **Stereo microphone: ME51S**

The built-in large-diameter microphone enables sensitive stereo recording.

- **2 channel microphone (omni-directional): ME30W**

Two ME30 monaural microphones come in a set with a miniature tripod and a connection adapter. These highly sensitive omni-directional microphones are supported by plug-in power and are well-suited to recording musical performances.

- **Compact Gun Microphone (unidirectional): ME31**

This directional microphone is useful for various types of recording such as outdoor recording of wild birds singing. The metal body provides sturdiness and high rigidity.

- **Compact zoom microphone (unidirectional): ME32**

This microphone is integrated with a tripod, making it suitable for recording audio at a distance, such as from your table at a meeting or conference.

- **Highly sensitive noise-cancellation monaural microphone (unidirectional): ME52W**

This microphone is used to record audio at a distance while minimizing surrounding noise.

- **Tie clip microphone (omni-directional): ME15**

This small unobtrusive microphone comes with a tie-clip.

- **Telephone pickup microphone: TP8**

This earphone-type microphone can be placed into your ear while you are phoning. The voice or conversation from the phone can be recorded clearly.

- **Ni-MH rechargeable battery and charger set: BC400 (For Europe)**

BC400 comes with an Ni-MH rechargeable battery charger (BU-400) and 4 Ni-MH rechargeable batteries (BR401). This charger can quick charge Olympus AA or AAA Ni-MH rechargeable batteries.

- **Ni-MH rechargeable battery: BR401**

High-efficiency rechargeable long life battery.

- **USB connecting AC adapter: A514**

5VDC AC Adapter for USB connection.

- **Connecting cord: KA333**

This connecting cord has stereo mini-plugs (ø3.5) with resistance at both ends. Use it to connect from the earphone jack output of the recorder to the microphone input jack when recording. Converting plug adapters (PA331/PA231) which convert to the monaural mini plug (ø3.5) or monaural mini plug (ø2.5) are also included.

- **USB cable: KP-19**

Specifications

General

■ Recording format:

Linear PCM* (Pulse Code Modulation)
MP3 (MPEG-1 Audio Layer3)
WMA (Windows Media Audio)
* WS-813, WS-812 only.

■ Sampling frequency:

Linear PCM format

44.1 kHz/16 bit *1	44.1 kHz
--------------------	----------

MP3 format

256 kbps *1	44.1 kHz
192 kbps *2	44.1 kHz
128 kbps	44.1 kHz

WMA format

128 kbps	44.1 kHz
64 kbps	44.1 kHz
32 kbps	44.1 kHz
16 kbps	22.05 kHz
8 kbps	8 kHz

*1 WS-813, WS-812 only

*2 WS-811 only

■ **Maximum working output:**
150 mW (8 Ω speaker)

■ **Maximum headphone output:**
≤ 150 mV (according to EN 50332-2)

■ **Wide band characteristic
headphone output:**
75 mV ≤ (according to EN 50332-2)

■ **Recording media:**
Built-in NAND FLASH memory:
WS-813: 8 GB/**WS-812:** 4 GB/
WS-811: 2 GB
microSD card:
2 GB to 32 GB

■ **Speaker:**
Built-in ø 18 mm round dynamic speaker

■ **MIC jack:**
ø 3.5 mm mini-jack, impedance 2 kΩ

■ **EAR jack:**
ø 3.5 mm mini-jack, impedance 8 Ω or
more

■ **Input power requirement:**
Battery:
AAA battery (LR03) or
Olympus Ni-MH rechargeable battery
External power supply:
USB connecting AC adapter (A514) 5 V

■ **External dimensions:**
100.2 mm × 40 mm × 14.8 mm
(without protrusions)

■ **Weight:**
57 g (including battery)

■ **Operating temperature:**
0°C - 42°C/ 32°F - 107.6°F

■ **Tuning frequency range
(WS-813 only):**
FM radio: 87.50 MHz to 108.00 MHz

Frequency response

- **During recording mode (Microphone jack):**
Linear PCM format

44.1 kHz/16 bit *1	40 Hz to 21 kHz
--------------------	-----------------

MP3 format

256 kbps *1	40 Hz to 20 kHz
192 kbps *2	40 Hz to 19 kHz
128 kbps	40 Hz to 17 kHz

WMA format

128 kbps	40 Hz to 19 kHz
64 kbps	40 Hz to 16 kHz
32 kbps	40 Hz to 13 kHz
16 kbps	40 Hz to 8 kHz
8 kbps	40 Hz to 3 kHz

*1 WS-813, WS-812 only

*2 WS-811 only

- **During recording mode (Built-in stereo microphone):**
70 Hz to 20 kHz
(However, for recording in the MP3 format or the WMA format, the upper limit value of the frequency response depends on the recording mode)
- **During playback mode:**
20 Hz to 20 kHz

Guide to battery life

The following values are strictly for reference only.

■ In recording mode (Internal memory):

Recording mode		Built-in stereo microphones	
		Alkaline battery	Ni-MH Rechargeable battery
Linear PCM format	44.1 kHz/16 bit *	20 h.	15 h.
MP3 format	128 kbps	22 h.	18 h.
WMA format	128 kbps	21 h.	17 h.
	8 kbps	27 h.	22 h.

■ In voice file playback mode (All Playback Mode):

Recording mode		Built-in speaker	
		Alkaline battery	Ni-MH Rechargeable battery
Linear PCM format	44.1 kHz/16 bit *	19 h.	15 h.
MP3 format	128 kbps	21 h.	17 h.
WMA format	128 kbps	21 h.	17 h.
	8 kbps	24 h.	20 h.

Recording mode		Earphone playback	
		Alkaline battery	Ni-MH Rechargeable battery
Linear PCM format	44.1 kHz/16 bit *	22 h.	17 h.
MP3 format	128 kbps	29 h.	21 h.
WMA format	128 kbps	30 h.	22 h.
	8 kbps	30 h.	22 h.

■ In FM radio mode (Internal memory) (WS-813 only):

Recorder status	Earphone playback	
	Alkaline battery	Ni-MH Rechargeable battery
During FM radio reception	12 h.	11 h.
During FM radio recording	7 h.	7 h.

* WS-813, WS-812 only.

Note

- Battery life is measured by Olympus. It varies greatly according to the type of battery used and the conditions of use.

Guide to recording times

The following values are strictly for reference only.

■ Linear PCM format:

Recording media		Recording mode	
		44.1 kHz/16 bit	
Internal memory	WS-813 (8 GB)	12 h. 5 min.	
	WS-812 (4 GB)	6 h.	
microSD card	8 GB	12 h. 5 min.	
	4 GB	6 h.	
	2 GB	3 h.	

■ MP3 format:

Recording media		Recording mode		
		256 kbps	192 kbps	128 kbps
Internal memory	WS-813 (8 GB)	66 h. 30 min.	—	133 h.
	WS-812 (4 GB)	33 h.	—	66 h. 30 min.
	WS-811 (2 GB)	—	22 h.	33 h. 30 min.
microSD card	8 GB	66 h. 30 min.	89 h.	133 h.
	4 GB	33 h.	44 h.	66 h.
	2 GB	16 h. 30 min.	22 h.	33 h.

■ WMA format:

Recording media		Recording mode				
		128 kbps	64 kbps	32 kbps	16 kbps	8 kbps
Internal memory	WS-813 (8 GB)	132 h.	261 h.	522 h.	1028 h.	2043 h.
	WS-812 (4 GB)	65 h.	129 h.	259 h.	511 h.	1016 h.
	WS-811 (2 GB)	32 h. 30 min.	65 h. 30 min.	131 h.	258 h.	514 h.
microSD card	8 GB	130 h.	261 h.	522 h.	1027 h.	2042 h.
	4 GB	64 h. 30 min.	129 h.	259 h.	510 h.	1014 h.
	2 GB	32 h. 30 min.	65 h.	129 h.	255 h.	508 h.

Notes

- Available recording time may be shorter if numerous short recordings are made (The displayed available recording time and recorded time are approximate indications).
- Variations in the available recording time will arise as there may be differences in the available memory depending on the microSD card.

Maximum recording time per file

- The maximum capacity for a single file is approx. 4 GB for WMA and MP3, and approx. 2 GB for Linear PCM*1 format (WAV).
- Regardless of the amount of remaining memory, the longest sound recording time per file is restricted to the following value.

Linear PCM format

44.1 kHz/16 bit *1	approx. 3 h. 20 min.
--------------------	----------------------

MP3 format

256 kbps *1	approx. 37 h. 10 min.
192 kbps *2	approx. 49 h. 30 min.
128 kbps	approx. 74 h. 30 min.

WMA format

128 kbps	approx. 26 h. 40 min.
64 kbps	approx. 26 h. 40 min.
32 kbps	approx. 26 h. 40 min.
16 kbps	approx. 53 h. 40 min.
8 kbps	approx. 148 h. 40 min.

*1 WS-813, WS-812 only

*2 WS-811 only

Guide to recordable number of songs

WS-813: 2,000 songs

WS-812: 1,000 songs

WS-811: 500 songs

(At 128 kbps, 4 minutes per song)

Specifications and design are subject to change without notice.

Technical assistance and support

The following contact information relates to technical support for Olympus recorders and software only.

- **Technical Hotline Number in the U.S. and Canada**

1-888-553-4448

- **User Support E-mail address in the U.S. and Canada**

distec@olympus.com

- **Technical Hotline Number in Europe**

Toll free number: 00800 67 10 83 00

available for Austria, Belgium, Denmark, Finland, France, Germany, Italy, Luxemburg, Netherlands, Norway, Portugal, Spain, Sweden, Switzerland, United Kingdom

Charged numbers for the Rest of Europe

+ 49 180 567 1083

+ 49 40 23773 4899

- **User Support E-mail address in Europe**

dss.support@olympus-europa.com

7

Technical assistance and support

For customers in Europe:



The "CE" mark indicates that this product complies with the European requirements for safety, health, environment and customer protection.



This symbol [crossed-out wheeled bin WEEE Annex IV] indicates separate collection of waste electrical and electronic equipment in the EU countries. Please do not throw the equipment into the domestic refuse. Please use the return and collection systems available in your country for the disposal of this product.



Applicable Product: WS-813/WS-812/WS-811



This symbol [crossed-out wheeled bin Directive 2006/66/EC Annex II] indicates separate collection of waste batteries in the EU countries. Please do not throw the batteries into the domestic refuse. Please use the return and collection systems available in your country for the disposal of the waste batteries.

EN

94

OLYMPUS®

OLYMPUS IMAGING CORP.

Shinjuku Monolith, 3-1 Nishi-Shinjuku 2-chome, Shinjuku-ku, Tokyo 163-0914, Japan.

Tel. +81 (0)3-3340-2111

<http://www.olympus.com>

OLYMPUS EUROPA HOLDING GMBH

(Premises/Goods delivery) Wendenstrasse 14-18, 20097 Hamburg, Germany.

Tel. +49 (0)40-237730

(Letters) Postfach 10 49 08. 20034 Hamburg, Germany.

<http://www.olympus-europa.com>