

**OLYMPUS®**

---

*Electronic Flash*

**FL-36R**

---

**Instruction Manual**



# Names of parts

## Flash

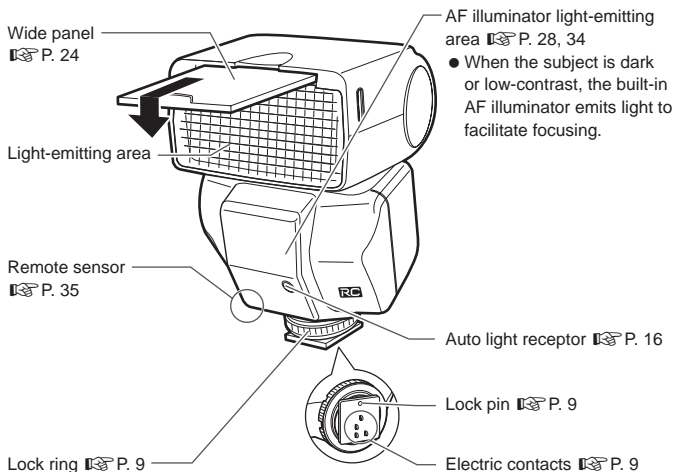

## Checking the package contents

The following items are included with the electronic flash.

If anything is missing or damaged, contact the dealer from whom you purchased the electronic flash.

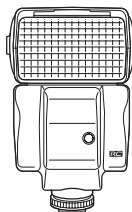

Electronic flash

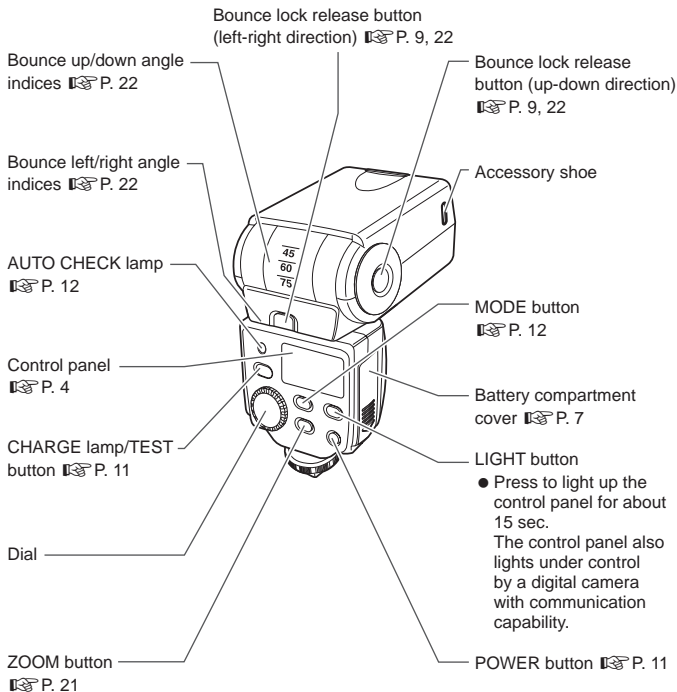

Flash stand  
FLST-1



Flash case

- Instruction manual (this manual)
- Warranty card

## Control panel

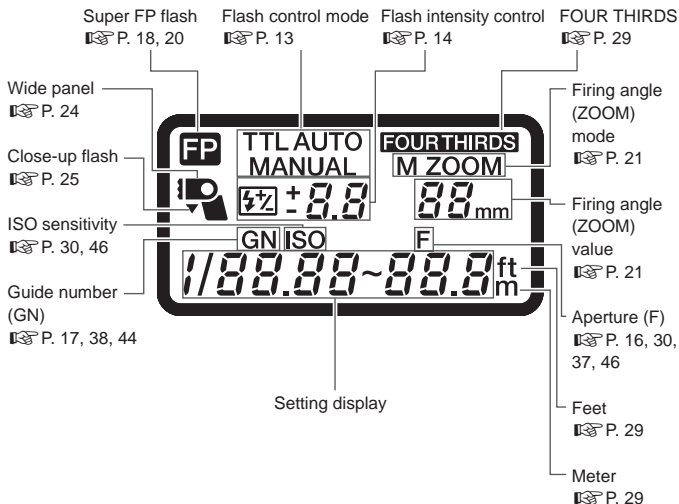

### Notes on this manual

The indications on the control panel may differ from those shown in the illustration above depending on the setup of the electronic flash, the camera in use, and the shooting conditions.

For example, the firing angle (ZOOM) can be displayed in either of the following modes.

- ① FOUR THIRDS..... Focal length of a Four Thirds System digital camera
- ② 135 ..... Focal length converted to an equivalent angle of view on a 135 type (35 mm film) camera

The text in this manual employs the [FOUR THIRDS] display mode and puts values in the [135] display mode inside parentheses, for example "(xx mm with the 135 type)". For the selection of the display modes, refer to "Custom setup" (P. 28).

# Table of contents

Names of parts .....	2
Flash .....	2
Control panel .....	4
Basic shooting .....	7
Loading batteries .....	7
Attaching to the camera .....	9
Turning on the electronic flash .....	11
Shooting .....	12
Flash intensity control .....	14
Other flash photography modes .....	16
AUTO .....	16
MANUAL .....	17
FP TTL AUTO .....	18
FP MANUAL .....	20
Setting the firing angle (ZOOM) .....	21
Bounce shooting .....	22
Using the wide panel .....	24
Close-up flash .....	25
Various flash shooting methods .....	26
Custom setup .....	28
All reset .....	31
Wireless flash .....	32
Basic wireless photography .....	33
About the placement of the electronic flash .....	35
Picture shooting using a digital camera without communication capability .....	37
AUTO .....	37
MANUAL .....	38
Slave flash .....	39
Warning display list .....	40
Q&A .....	41
Guide number (GN) list .....	44

Light control range in AUTO mode .....	46
Continuous firing.....	47
Safety precautions (Be sure to read and observe the following) .....	48
Caution for usage environment .....	52
Specifications .....	54

# Basic shooting

## Loading batteries

The batteries are available separately. Always use one of the following battery combinations.

- AA (R6) alkaline batteries/AA (R6) NiMH batteries/  
AA (R6) lithium batteries/AA (R6) oxyride batteries/  
AA (R6) NiCd batteries : x 2
- Lithium battery packs (CR-V3 type) (Olympus LB-01) : x 1

### ! Notes

- AA (R6) manganese batteries cannot be used.
- Do not mix old and new batteries or batteries of different types together.
- Carry spare batteries when traveling or when using the electronic flash in cold areas.

- 1 Open the battery compartment cover.

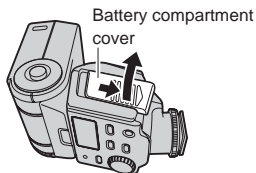

- 2 Insert the batteries with correct +/- polarity.

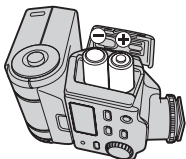

AA (R6) batteries

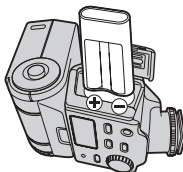

CR-V3

- 3 Close the battery compartment cover.

## Flash interval and flash count

Batteries used	Flash interval	Flash count
AA (R6) alkaline batteries	Approx. 7.5 sec.	Approx. 140 times
AA (R6) NiMH batteries (2,400 mAh)	Approx. 5.5 sec.	Approx. 200 times
AA (R6) lithium batteries	Approx. 7.5 sec.	Approx. 260 times
AA (R6) oxyride batteries	Approx. 6.5 sec.	Approx. 140 times
CR-V3 lithium battery pack	Approx. 6.5 sec.	Approx. 320 times

\* Measurements obtained from in-house tests at Olympus. Actual figures may vary depending on shooting conditions.

## Attaching to the camera

Confirm that both the camera and electronic flash are off.  
Attaching or removing the electronic flash while either the flash or the camera is on may result in malfunction.

- 1 Pressing the bounce lock release button, place the light-emitting section in standard position (horizontal, front).

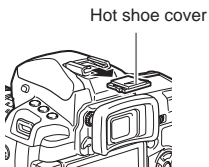
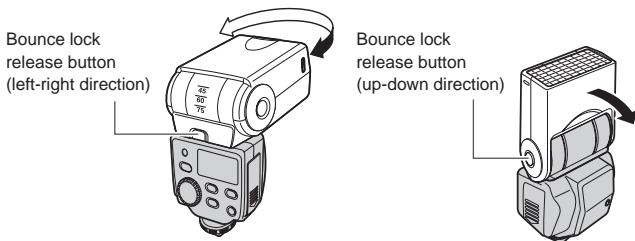

- 2 Remove the hot shoe cover from the camera.

- Store the hot shoe cover in the pocket located on the inner side of the flash case.

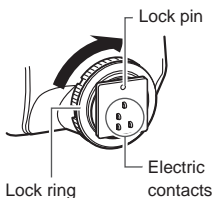

- 3 Loosen the lock ring.

- If the lock pin is protruding, pull it back inside by turning the lock ring as far as it will go in the direction opposite to LOCK.

### ! Notes

- Do not apply excessive force to the lock pin.
- Do not touch the electric contacts with a finger or metallic object.
- Do not attach the electronic flash while the lock pin is protruding. Otherwise, malfunction may result.

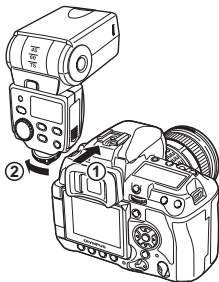



- Slide the electronic flash all the way into the hot shoe until it stops with a click (1).
- Turn the lock ring as far as it will go in the direction of LOCK (2).

### How to remove

- Loosen the lock ring completely, then slide the electronic flash out of the hot shoe.
- Attach the hot shoe cover to the camera.

---

### Using with a camera not equipped with hot shoe

- If the camera has an external flash connector, connect the electronic flash using the flash bracket and bracket cable (optional).
- The electronic flash can be used as a wireless flash with cameras compatible with the Olympus wireless RC flash system.  "Wireless flash" (P.32)
- The electronic flash can be used as a slave flash with cameras equipped with the slave mode or manual flash mode.  "Slave flash" (P.39)

## Turning on the electronic flash

Turn on the camera and electronic flash only after attaching to the camera. After turning on the electronic flash, be sure to check the remaining battery charge.

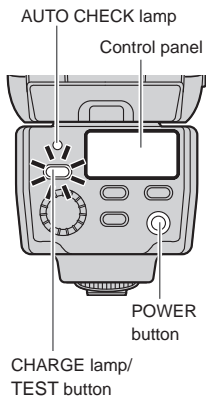

### 1 Press the POWER button.

- The control panel lights up and battery charging starts.
- Press the POWER button again to turn the electronic flash off.

### 2 Verify that the CHARGE lamp lights up.

- Replace the batteries if the time it takes for the CHARGE lamp to light up exceeds the following values.

Alkaline or oxyride batteries	30 sec. or more
NiMH or lithium batteries	10 sec. or more

- If the CHARGE lamp and AUTO CHECK lamp blink simultaneously, it means that the battery capacity is running low. In this case, replace the batteries.
- Press the TEST button to test the flash activation.

## Shooting

Let's try shooting pictures using the TTL AUTO mode. In TTL AUTO mode the flash intensity is controlled automatically according to the camera's settings.

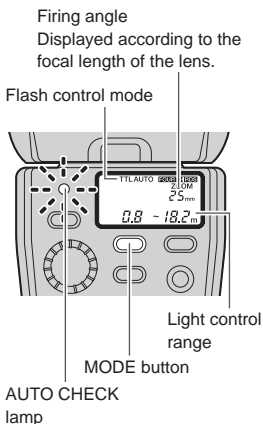

- 1 Set the camera's shooting mode to **P** (Program Auto).
- 2 Press the MODE button of the electronic flash repeatedly to set the flash control mode to [TTL AUTO].
- 3 Press the shutter button halfway.
  - Shooting information will be communicated between the camera and the electronic flash and the light control range will be displayed on the control panel.
  - If the subject is not within the light control range, adjust the distance to the subject.
  - The light control range will vary according to the camera's setup (ISO sensitivity, aperture value and focal length of the lens).
- 4 Press the shutter button fully.
  - When flash activation has been performed correctly, the AUTO CHECK lamp blinks for about 5 seconds after the shutter is released.

## Flash control modes

Select the flash control mode according to the subject and the shooting conditions. Press the MODE button repeatedly to change the flash control mode.

Control panel display	Control operation	Main application	Ref. page
TTL AUTO	The flash light intensity is controlled automatically according to the camera's setup. The flash will be adjusted based on the brightness taken through the camera's lens.	Usually use this mode with a camera with communication capability.	P. 12
AUTO	The flash light intensity is controlled automatically according to the camera's setup. The flash will be adjusted based on the brightness captured by auto light receptor on the electronic flash.	If the camera has communication capability, this mode can be used only when the camera is an AUTO-compatible model.	P. 16
MANUAL	In this mode, the flash is emitted according to the guide number setting.	Shooting using manual flash.	P. 17
<b>FP</b> TTL AUTO	Super FP flash. This mode allows you to use flash photography even at shutter speeds faster than the flash synchronization speed of the camera. In AUTO mode the flash light intensity is controlled automatically. In MANUAL mode the flash is emitted according to the guide number selected.	Outdoor shooting using flash, such as fill-in flash shooting in the daytime.	P. 18, 20
<b>FP</b> MANUAL			

### Notes

- Certain modes may be unavailable depending on the shooting mode set on the camera and the functions of the camera in use.
- It is not possible to select an unavailable mode.

## Operation of the flash in each shooting mode

Values and operation details in the table will vary depending on the camera. Refer to your camera's instruction manual.

Shooting mode	Flash emission	Shutter speed	Aperture
<b>P</b>	The flash is emitted automatically when either backlight or a brightness level requiring flash is detected.	The camera sets the shutter speed automatically. At the shooting conditions that will trigger a flash emission, shutter speed is fixed at 1/30 or 1/60.	The camera sets the aperture automatically.
<b>A</b>		The camera sets the shutter speed automatically. At the shooting conditions that will require slower shutter speeds, shutter speed is fixed at 1/30 or 1/60.	The aperture will be set to the value you select. Use the guide number and the light control range as a reference when setting the aperture value.  "Guide number (GN) list" (P. 44), "Light control range in AUTO mode" (P. 46)
<b>S</b>	The flash will always be emitted at shutter speeds slower than the flash synchronization speed of the camera. The flash will always be emitted with Super FP flash.	The shutter speed will be set to the value you select.	The camera sets the aperture automatically.
<b>M</b>			The aperture will be adjusted to the value you select.

## Flash intensity control

The flash light intensity can be adjusted between +3 and -3.

**1** In the custom setup, set the flash intensity control to [on].

 "Custom setup" (P. 28)

- The  indicator appears in the control panel.

## Flash intensity control

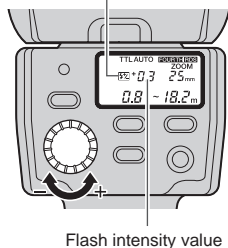

## 2 Turn the dial to select a flash intensity value.

- Turning the dial toward + will change the value as follows: 0 ▶ +0.3 ▶ +0.7 ▶ +1.0... ▶ +3.0.
- Turning the dial toward – will change the value as follows: 0 ▶ -0.3 ▶ -0.7 ▶ -1.0... ▶ -3.0.

## 3 When the camera's flash intensity control mode is set, the actual flash light intensity will be the total of the flash intensity value set on the electronic flash and that set on the camera.

- The flash intensity value displayed on the control panel is that of the electronic flash only.

e.g.)

	Selected adjustment value	Adjustment value displayed on the control panel	Actual flash intensity value
Flash	+0.3	+0.3	+0.6
Camera	+0.3		

## ! Notes

- In MANUAL and FP MANUAL mode settings on the camera will be ignored.

# Other flash photography modes

## AUTO

The flash light intensity is controlled automatically by measuring the amount of light through the auto light receptor. This mode uses the settings on the camera together with the settings on the electronic flash.

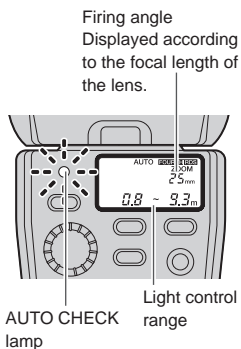

**1** The control panel shows the light control range according to the camera's setup.

- The light control range is not displayed if the camera's setup (ISO sensitivity and aperture value) does not match one of the usable ISO sensitivity/aperture value combinations. In this case, the [ISO] and [F] indicators blink to alert you. Change the camera's setup (ISO sensitivity and/or aperture value). "Light control range in AUTO mode" (P. 46)

**2** When flash activation has been performed correctly, the AUTO CHECK lamp blinks for about 5 seconds after the shutter is released.

### Test flash activation

Flash activation can be tested before actually releasing the shutter.

Press the TEST button for test flash activation.

If the AUTO CHECK lamp blinks for about 5 seconds after the test flash activation, the flash is adjusted correctly.

If the lamp does not blink, change the aperture value, ISO sensitivity, subject distance, etc.

- Checking the light by means of test flash activation is possible only in AUTO mode.

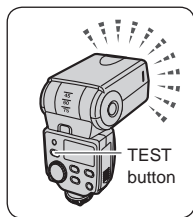

In this mode, the flash is emitted according to the guide number (GN) setting.

Firing angle  
Displayed according to the  
focal length of the lens.

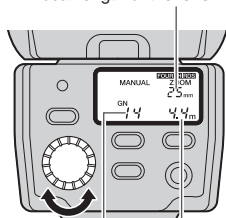

Guide number      Optimum shooting  
distance

## 1 Turn the dial to set the guide number.

- The control panel shows the guide number set and the optimum shooting distance according to the camera's setup.

## 2 If the distance to the subject does not match the optimum shooting distance, change the guide number or the distance to the subject.

- The optimum shooting distance varies according to the camera's setup (ISO sensitivity, aperture value, lens focal distance and shutter speed). For details refer to "Guide number (GN) list" (📖 P. 44).

---

### Optimum shooting distance

When the ISO sensitivity is set to 100, you can calculate the optimum shooting distance by dividing the guide number (GN) by the aperture value (F). 📖 "Guide number (GN) list" (P. 44)

## FP TTL AUTO

In this mode, the electronic flash uses Super FP flash to synchronize with high shutter speeds.

The following operations are possible using Super FP flash.

- Attenuation of shades when shooting a backlit picture.
- Outdoor portrait shooting using daytime fill-in flash shooting with the aperture opened up to blur the background.

### Shooting against light



Without flash



With flash (FP TTL AUTO)

### Portrait shooting



With aperture adjusted



With aperture open

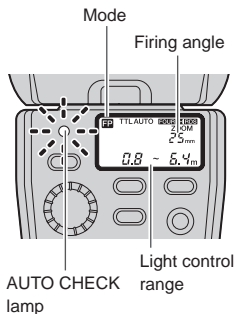

- 1 The control panel shows the light control range according to the camera's setup.
- 2 Confirm that the distance to the subject is within the light control range.
  - If it is not within the light control range, change the distance to the subject or the camera's setup.
  - The light control range varies according to the camera's setup (ISO sensitivity, aperture value, lens focal length and shutter speed).
- 3 When flash activation has been performed correctly, the AUTO CHECK lamp blinks for about 5 seconds after the shutter is released.

#### **!** Notes

- With Super FP flash the highest guide number will be lower than in TTL AUTO mode. As a result, the light control range will be shortened.

In this mode, Super FP flash is performed at the set flash intensity.

### Firing angle

Displayed according to the focal length of the lens.

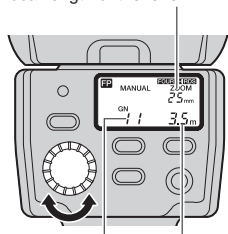

Guide number      Optimum shooting distance

### 1 Turn the dial to set the guide number.

- The control panel shows the guide number set and the optimum shooting distance according to the camera's setup.

### 2 If the distance to the subject does not match the optimum shooting distance, change the settings or the distance to the subject.

- The optimum shooting distance varies according to the camera's setup (ISO sensitivity, aperture value, lens focal distance and shutter speed). For details refer to "Guide number (GN) list" (P. 44).

## Optimum shooting distance

When the ISO sensitivity is set to 100, you can calculate the optimum shooting distance by dividing the guide number (GN) by the aperture value (F). (P. 44) "Guide number (GN) list"

## Setting the firing angle (ZOOM)

The firing angle can be adjusted manually.

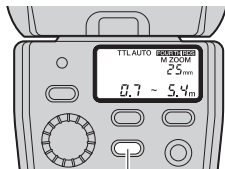

ZOOM button

### 1 Press the ZOOM button to adjust the firing angle.

- The [M ZOOM] indicator lights in the control panel.
- The firing angle can be set to one of 12, 14, 17, 25, 35 and 42 mm (24, 28, 35, 50, 70 and 85 mm with the 135 type). Each press of the ZOOM button switches the firing angle as follows.

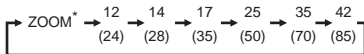

When the wide panel is used

☞ “Using the wide panel” (P. 24):

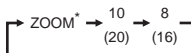

- \* [ZOOM] (auto) can be selected only when the camera in use is equipped with the communication capability.

### ! Notes

- Selecting a value larger than the focal length of the lens in use will darken the peripheral areas of the image.

## Bounce shooting

Bounce shooting refers to a method in which the light from the flash is bounced off the ceiling or walls.

This allows the light to go all around the subject, resulting in a soft picture without harsh contrast or shadow.



Shooting without bounce



Shooting with bounce

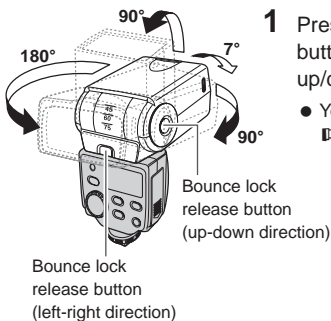

1 Pressing the bounce lock release button, turn the light-emitting section up/down and left/right.

- You can turn it down: 7°  
☞ “Close-up flash” (P. 25)

### ! Notes

- When the light-emitting section is at the bounce position, the light control range and optimum shooting distance are not displayed in the control panel.
- The color of the surface (ceiling and/or walls) off which the light is bounced will affect the pictures you take. Whenever possible, bounce the light off a neutral surface (white or very light grey will work best).
- The firing angle will be set automatically to 25 mm (50 mm with the 135 type), and “- -” will be displayed on the control panel. You can press the ZOOM button to adjust the firing angle manually. ☞ “Setting the firing angle (ZOOM)” (P. 21)

## Using the reflector adapter (optional)

When you use an optional reflector adapter to shoot with bounce flash, you can divert part of the light toward the subject to reflect it off the subject. In this way you can achieve a catch-light effect — the light reflection on people's eyes. You can also illuminate with the reflector light parts of the picture that might have been shaded because of the bounce flash.

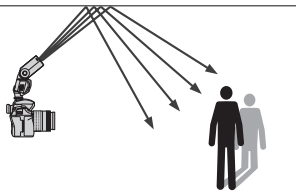

Shooting with bounce alone

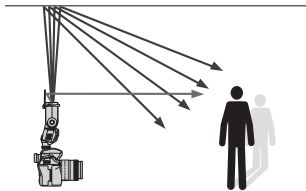

Shooting with reflector adapter

To achieve the catch-light effect, turn the light-emitting section directly up or directly sideways and aim the plate towards the subject.

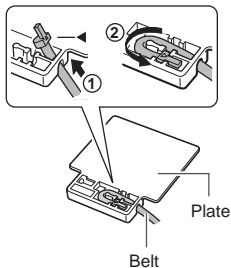

- 1 Pass the end with the ◀ mark of the reflector adapter's belt through the plate (①) and insert the ◀ part of the belt into the plate (②).

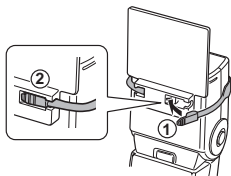

- 2 Align the flat surface of the plate with the electronic flash and wrap the belt around the flash (①). Insert the other end of the belt firmly into the plate (②).

## Using the wide panel

Use the built-in wide panel in flash shooting when the lens focal length is set to a position wider than 12 mm.

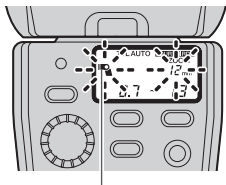

Wide panel

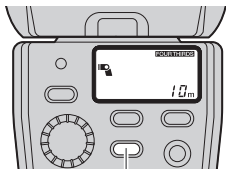
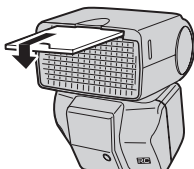

ZOOM button

- 1 When the lens focal length is shorter than 12 mm (24 mm with the 135 type), the wide panel warning indicator blinks in the control panel.

- This does not occur if the camera is not equipped with communication capability.

- 2 Slide out the wide panel and place it on the light-emitting area.

- The wide panel indicator lights up in the control panel.

- 3 Press the ZOOM button to adjust the firing angle.

- The firing angle can be selected from 8 mm and 10 mm (16 mm and 20 mm with the 135 type).

- When the wide panel is used, the guide number will be lower, and the available shooting range or the optimum shooting distance will be shortened.

### ! Notes

- To prevent damage to the wide panel, do not flip it in the upward direction.
- If the wide panel is damaged when it is slid out, the ZOOM button will no longer be operable. If that happens, disable the wide panel switch to restore operability.  
☞ "Custom setup" (P. 28)

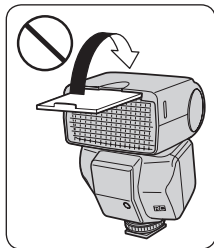

## Close-up flash

When the distance to the subject is between 0.5 m (1.6 ft.) and 1.0 m (3.3 ft.), the flash light emission area will not match the range included in the shot. In this case, point the flash to the down-most angle (7°) using the bounce lock release button.

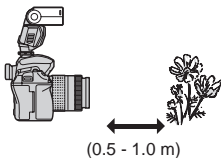

- 1 Pressing the bounce lock release button, tilt the light-emitting section to the down-most angle (7°). The close-up flash indicator lights in the control panel.

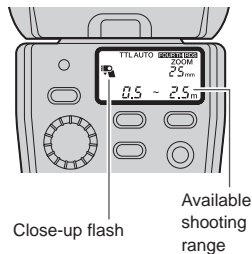

### ! Notes

- The available shooting range is up to 2.5 m.
- The flash light may be blocked when the lens is long or large in diameter. Be sure to perform test shooting.
- Do not use this function for any purpose other than close-up shooting. If it is used in normal shooting, there will be insufficient illumination for the upper half of the picture.

## Various flash shooting methods

The following flash shooting methods are possible according to the camera's setup.

- Some flash shooting methods may be unavailable depending on the function and design of the camera.
- For details on how to use these modes, refer to the instruction manual for your camera.

### Red-eye reduction flash

Reduces the appearance of red eyes due to flash emission.



### Slow synchronization

The flash is emitted while the shutter is open for a longer time. Usually when the flash is emitted, the shutter speed is fixed. However in this mode, the shutter speed is extended depending on the brightness. You will be able to take great pictures of people in night or twilight scenes.



## Second curtain synchronization

A slow shutter is used and the flash is emitted immediately before the end of the exposure period.

This makes it possible to take pictures of moving objects such as car taillights with a streaming effect.



## Combination with camera's built-in flash

When the camera in use has a built-in flash, it can be used simultaneously with the electronic flash.

- For example, you can bounce the light from the electronic flash off the wall or ceiling while using the camera's built-in flash for a catch-light effect. Advanced shooting techniques are possible.
- With certain camera models, the built-in flash may be disabled when the electronic flash is attached to the camera's hot shoe.

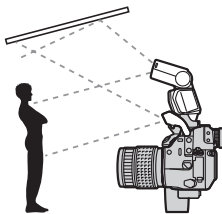

### ! Notes

- The electronic flash control mode should be set to TTL AUTO or FP TTL AUTO.



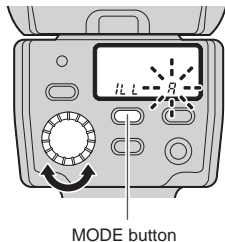

# Custom setup

Custom setup allows you to customize the electronic flash to suit your preferences.



- 1 Press and hold the MODE button for more than 2 seconds, until the setup mode display appears in the control panel.
- 2 Press the MODE button to select the setup mode.
- 3 Turn the dial to select the value.
- 4 Press and hold the MODE button for more than 2 seconds to confirm the setup.

Setup mode	Mode display	Value display	Function	Default value
	MODE button	Dial		
AF illuminator	ILL	A	AF illuminator is activated according to the control from the camera.	A
		OFF	AF illuminator is off.	
Flash cable	CLP	ON	Use this setting when not using the flash cable (attaching to the hot shoe or using a clip-on).	on
		OFF	Use this setting when using the flash cable (off-flash cable).	

Setup mode	Mode display	Value display	Function	Default value
	MODE button	Dial		
Firing angle (ZOOM) display	 -- mm	4-3	Firing angle is displayed in terms of the lens focal length of a FOUR THIRDS camera.	4-3
	ZOOM -- mm	135	Firing angle is converted into the focal distance of the 135 type. This allows the flash to be used in the same feeling as the flash for a 135 type (35 mm film) camera.	
Distance display unit		m	Distance is displayed in meter.	m
		ft	Distance is displayed in feet.	
Flash intensity control		OFF	Flash intensity cannot be adjusted.	OFF
		on	Flash intensity can be adjusted.	
Wide panel switch disabling		on	The wide panel switch is activated. Use this setting to detect that the wide panel has been slid out.	on
		OFF	The wide panel switch is deactivated. Use this setting when the wide panel is damaged so as to be able to change the firing angle with the ZOOM button.	
Guide number display	GN	on	The flash intensity is displayed in a guide number.	on
		OFF	The flash intensity is displayed in a flash intensity ratio.	

Setup mode	Mode display		Value display	Function	Default value
	MODE button		Dial		
ISO, F communication in AUTO mode ● Available only in AUTO mode, with cameras with communication capability.	ISO	F	ON	The ISO sensitivity and aperture value setup will be adjusted automatically by the camera.	on
			OFF	You can adjust the ISO sensitivity and aperture value on the electronic flash.	
ISO sensitivity selection in AUTO mode ● Works with a camera without communication capability. Also works with a camera with communication capability when the ISO, F communication is set to [OFF].	ISO		25   3200	The ISO sensitivity can be set with the dial.	100

# All reset

All reset resets the custom setups to the factory default settings.

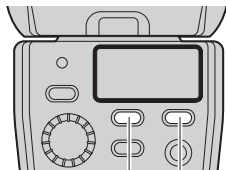

MODE button

LIGHT button

- 1** Press the MODE and LIGHT buttons simultaneously for 2 or more seconds to reset to default settings.
  - The distance display unit (m/ft) is not altered by the all reset operation.

## Wireless flash

This flash is compatible with the Olympus wireless RC flash system. Using the electronic flash with an Olympus digital camera that is also compatible with this system, gives you wireless remote control over the flash emission. The flash mode and other controls are set on the camera and it controls the electronic flash automatically.

You can also combine several flashes to create a multiple flash array. To find out if your camera is compatible with this system, refer to the camera's instruction manual.

In wireless photography mode, the camera controls the electronic flash through a light communication system with the camera's built-in flash. Adjust the following settings on the camera and the electronic flash in advance.

### RC mode:

This is the wireless mode. Set both the camera and the electronic flash to RC mode.

### Channel:

Changes the channel so the camera will not receive mistaken signals from other Olympus wireless RC flash systems operating nearby. Select a channel between 1 and 4 and set the same channel on the camera and the electronic flash.

### Group:

You can control remotely up to three groups (A, B, C) of flash arrays with different flash modes and other settings. On the electronic flash set in advance the group with which the flash will be emitted.

## Basic wireless photography

This function will be explained using an example of the electronic flash used together with an Olympus digital SLR camera E-3. Refer to the camera's instruction manual for details on the setup range of flash and the operations on the camera.

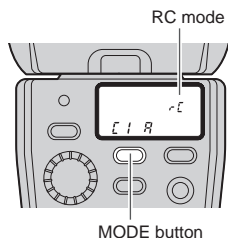

- 1 Place the camera and the electronic flash. "About the placement of the electronic flash" (P. 35)
- 2 Press the MODE button of the electronic flash repeatedly to set the flash control mode to RC mode.

- 3 Set [ RC MODE] on the camera to [ON] and set the camera's built-in flash to a condition that it can be emitted.

- Set the flash mode and the flash intensity on the camera.

Group

- Select the flash mode and adjust the flash intensity individually for groups A, B, and C. For MANUAL mode, select the flash intensity.

Flash intensity value

Flash control mode

Flash intensity

Normal flash/Super FP flash

- Switch between normal flash and Super FP flash.

Communication light level

- Set the communication light level to [HI], [MID], or [LO].

Channel

- Set the communication channel to the same channel used on the electronic flash.

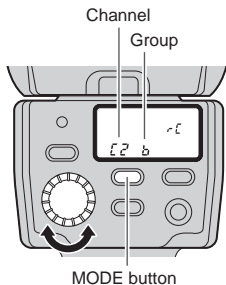

**4** While holding down the MODE button, turn the dial to select the channel and group.

- When 2 seconds pass with the MODE button held, the camera enters custom setup.

**5** After shooting preparations are completed, take some test shots to check the flash operation and images.

**6** Begin shooting while checking the charging completed indications of the camera and the electronic flash.

- The charge condition of the electronic flash is not communicated to the camera. Shoot the picture only after checking that the CHARGE lamp at the back of the electronic flash is on, or that the AF illuminator part at the front of the electronic flash is blinking.
- When the camera's flash intensity control mode is set, the actual flash light intensity will be the total of the flash intensity value set on the electronic flash and that set on the camera.

### **!** Notes

- The firing angle of the flash cannot be controlled automatically so be sure to check it beforehand. Pressing the ZOOM button on the electronic flash once will display the firing angle for about 2 seconds. You can change the firing angle by pressing ZOOM button again while the current firing angle is displayed. Verify whether the firing angle setting is appropriate or not by performing a test shot.
- When shooting using 2nd curtain synchronization, set the shutter speed up to 4 seconds since the flash will be emitted automatically after about 5 seconds.
- In RC mode the built-in flash of the camera is used to send the remote control signal and therefore cannot be used as a flash.



## Placement examples: Placement of three flashes

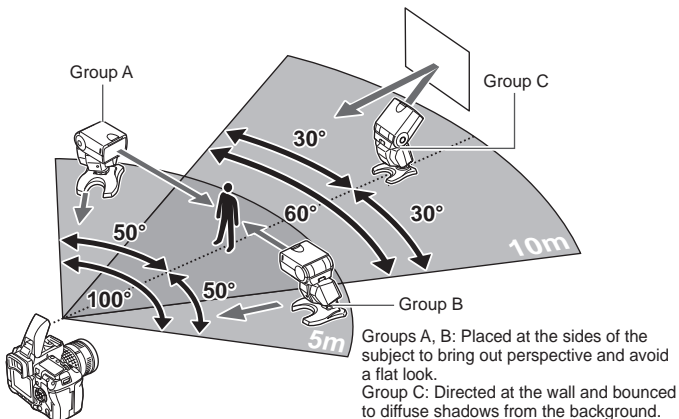

## Changing the amount of light of each flash

When shooting with multiple flashes you can create different effects of the flash photography by changing the amount of light of each flash. First, try to change the flash mode and flash intensity value for each group. If that is not enough to create the expression you want, try the following.

- Change the distance between the electronic flash and the subject.
- Change the flash intensity value on the electronic flash.
- Change the firing angle.

### ! Notes

- If there is an object between the camera's built-in flash and the electronic flash it may obstruct the light signal and the flash may not be emitted.
- If enough light can be reflected back from the subject or from the background (for example a wall when shooting indoors), the arrangement will work even if it is not perfectly aligned.
- Although there is no limit to the number of wireless flashes you can use, it is recommended that each group have no more than three flashes to prevent flash malfunction due to mutual interference.
- Place flashes that are to be emitted in AUTO mode so that the auto light receptor will face the subject. In such case, the remote sensor will not face the camera so the flash will be emitted making use to reflected light from the subject or background.
- After you finish placing the electronic flash, be sure to perform a test shot.

# Picture shooting using a digital camera without communication capability



When using the electronic flash with a camera without communication capability, adjust the ISO sensitivity and aperture value in AUTO mode to the same values as on the camera or change the shooting distance in MANUAL mode.

You can also emit the flash wirelessly as a slave flash.  "Slave flash" (P. 39)

## AUTO

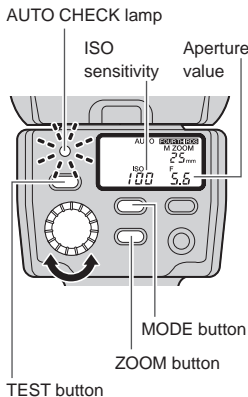
In this mode, the flash light intensity is controlled automatically according to the aperture setting.



- 1 While holding down the MODE button, turn the dial to adjust the ISO sensitivity.
  - When 2 seconds pass with the MODE button held, the camera enters custom setup.
- 2 Press the ZOOM button to adjust the firing angle according to the focal distance of the lens.
- 3 Turn the dial according to the aperture value of the lens.
  - If the ISO sensitivity/aperture value combinations do not match the usable range, the ISO sensitivity and aperture value blink to alert you. In this case, change the ISO sensitivity and/or aperture value.  "Light control range in AUTO mode" (P. 46)
  - Press the TEST button to test the flash activation.  "Test flash activation" (P. 16)
- 4 When flash activation has been performed correctly, the AUTO CHECK lamp blinks for about 5 seconds after the shutter is released.

### Flash intensity value

By selecting an ISO sensitivity and aperture value different from those set on the camera, the flash intensity can be adjusted in 1/3 steps.

## MANUAL

In this mode, the flash is emitted according to the guide number (GN) setting.

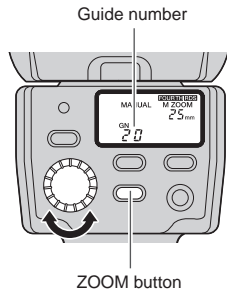

- 1 The control panel shows the current guide number.
  - Flash intensity can also be displayed as flash intensity ratio. “Custom setup” (P. 28)
  - Flash intensity ratio: Ratio of emitted flash intensity with respect to the intensity at full emission.
- 2 Press the ZOOM button to adjust the firing angle according to the focal distance of the lens.
- 3 Turn the dial to set the guide number.

### How to determine the aperture value and guide number

#### **When the shooting distance and aperture value are already determined:**

Determine the guide number with the following formula and set the value on the electronic flash.

$$\text{Guide number (GN)} = \frac{\text{Aperture value (F)} \times \text{Shooting distance (m)}}{\text{ISO sensitivity coefficients}}$$

#### **When it is necessary to determine the aperture value:**

Determine the aperture value with the following formula and set the value on the electronic flash.

$$\text{Aperture value (F)} = \frac{\text{Guide number (GN)} \times \text{ISO sensitivity coefficient}}{\text{Shooting distance (m)}}$$

#### **When it is necessary to determine the optimum shooting distance:**

$$\text{Optimum shooting distance (m)} = \frac{\text{Guide number (GN)} \times \text{ISO sensitivity coefficient}}{\text{Aperture value (F)}}$$

### **ISO sensitivity and their coefficients**

<b>ISO sensitivity</b>	25	50	100	200	400	800	1600	3200
<b>Coefficient</b>	0.5	0.71	1.0	1.4	2.0	2.8	4.0	5.6

## Slave flash

The electronic flash is equipped with the slave function. In this function you can emit the flash with a wireless remote control by synchronizing it to the emission of another flash.

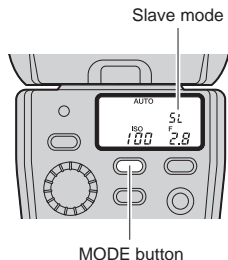





- 1 Place the electronic flash.
  - Refer to “About the placement of the electronic flash” (👉 P. 35).
- 2 Press the MODE button of the electronic flash repeatedly to set the flash control mode to [SL AUTO] or [SL MANUAL].
  - The flash setup is the same as in AUTO or MANUAL mode. 👉 “AUTO” (P. 37), “MANUAL” (P. 38)
- 3 Setup the camera in the following way.
  - Set cameras with slave mode to slave mode.
  - Set cameras with manual flash emission mode to manual flash mode. This setup will function also if you attach an external flash with manual flash emission mode to the camera.

### ! Notes

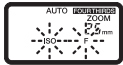
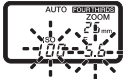
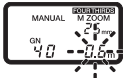
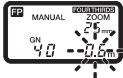
- The slave flash mode cannot be used with cameras that perform a pre-flash because the electronic flash will be emitted simultaneously with the pre-flash.
- If other photographers are shooting using flash, the electronic flash may react to those lights and be emitted.
- The firing angle of the flash cannot be controlled automatically so be sure to check it beforehand. Pressing the ZOOM button on the electronic flash once will display the firing angle for about 2 seconds. You can change the firing angle by pressing ZOOM again while the current firing angle is displayed. Verify whether the firing angle setting is appropriate or not by performing a test shot.

# Warning display list

Warning details	Control panel display	Remedy	Ref. page
In AUTO mode: Out of light control range	 <p>(camera with communication capability)</p>	Change the camera's ISO sensitivity or aperture setting.	P. 16
	 <p>(camera without communication capability)</p>		P. 37
In MANUAL mode: Subject too close		<p>When the optimum shooting distance is less than 0.6 m (1.9 ft.) (0.5 m (1.6 ft.) in case of close-up flash), the displayed value blinks to alert you that the shooting range does not match the light emission area of the flash.</p> <ol style="list-style-type: none"> <li>Change the camera's ISO sensitivity or aperture setting.</li> <li>Change the guide number setting.</li> </ol>	P. 17
In FP MANUAL mode: Subject too close		<ol style="list-style-type: none"> <li>Change the camera's ISO sensitivity or aperture setting.</li> <li>Change the guide number setting.</li> </ol>	P. 20
In all modes: Wide panel request warning		Set the wide panel.	P. 24
In all modes: Downward bounce		The light-emitting section is tilted 7° downwards. Cancel this setting except for close-up flash photography.	P. 25
In all modes: Wide panel warning		The wide panel is set. Pay attention to the distance to the subject since the guide number will be lower.	P. 24

## Q&A

- Q** When are test flash activation and auto checking effective?
- A** Checking the optimum flash activation based on the AUTO CHECK lamp is particularly effective in bounce flash (in AUTO modes only).
- Q** Why does the electronic flash get hot after successive emissions?
- A** The batteries generate heat when flash is emitted repeatedly. In this case, use the electronic flash at intervals until the flash emission section and batteries cool down.
- Q** Why can't I mount the electronic flash on the camera?
- A** The electronic flash cannot be attached if the lock pin is protruding. In such case, turn the lock ring as far as it will go in the direction opposite to LOCK (👉 P. 9).
- Q** Why doesn't the flash control mode change when I press the MODE button?
- A** When the electronic flash is connected to certain types of communication-capable cameras, the flash control mode can only be controlled from the camera.
- Q** What is the recommended white balance setting for the camera when using the electronic flash?
- A** The auto white balance mode is recommended. If you use the manual white balance mode, set the color temperature to around 5500K. Note that the color temperature varies depending on the flash intensity.
- Q** The AF illuminator does not light up. What is wrong?
- A** The AF illuminator only works when you use the electronic flash with Olympus Four Thirds System digital SLR cameras. It does not work with other cameras. The AF illuminator will not work also when lenses large in diameter that can obstruct it are attached to the camera.

**Q** The light control range is not displayed on the control panel. What is wrong?

**A** The light control range is not displayed in the following cases:

- When the extension tube EX-25 (optional) is used.
- When the lens has been removed.
- In bounce shooting.
- When the ISO sensitivity and aperture value are out of the setting range.

**Q** The flash wasn't emitted when shooting in RC mode. What is wrong?

**A** Verify that the camera and the electronic flash are set to the same channel and that the group is set correctly (👉 P. 34).

**Q** How can I find out if my camera is compatible with wireless flash?

**A** You can use the RC mode only with cameras compatible with the Olympus wireless RC flash system. With other cameras you may be able to use the electronic flash as slave flash if the camera's built-in flash can be set to slave flash mode or manual flash mode. For details, refer to the camera's instruction manual.

**Q** When the Olympus digital camera entered the sleep mode, the control panel on the electronic flash turned off as well. Is this normal?

**A** Yes, it is normal. When the camera enters the sleep mode, the FL-36R does as well. When the camera wakes up, so does the FL-36R. After approximately 15 minutes in sleep mode, the FL-36R turns off. In such a case, press the POWER button to turn the FL-36R back on.

**Q** Does the FL-36R also turn off when the Olympus digital camera is turned off?

**A** When the camera is turned off, the FL-36R enters the sleep mode. After approximately 15 minutes, the FL-36R automatically turns off. In such a case, press the POWER button to turn the FL-36R back on.

**Q** Why did the FL-36R automatically turn off?

**A** The FL-36R automatically turns off in RC mode and slave mode when no operations are performed for 60 minutes. When connected to a camera without communication capability, the FL-36R enters the sleep mode if it is not operated for about 15 minutes. After another 15 minutes, the power turns off.

# Guide number (GN) list

## ● TTL AUTO/AUTO

ISO100, m

ZOOM (mm)	FOUR THIRDS	8	10	12	14	17	25	35	42
	With 135	16	20	24	28	35	50	70	85
TTL AUTO/AUTO	Full emission	12	14	20	22	24	28	32	36

## ● MANUAL

ISO100, m

ZOOM (mm)	FOUR THIRDS	8	10	12	14	17	25	35	42
	With 135	16	20	24	28	35	50	70	85
MANUAL	1/1	12.0	14.0	20.0	22.0	24.0	28.0	32.0	36.0
	1/2	8.5	9.9	14.1	15.6	17.0	19.8	22.6	25.5
	1/4	6.0	7.0	10.0	11.0	12.0	14.0	16.0	18.0
	1/8	4.2	4.9	7.1	7.8	8.5	9.9	11.3	12.7
	1/16	3.0	3.5	5.0	5.5	6.0	7.0	8.0	9.0
	1/32	2.1	2.5	3.5	3.9	4.2	4.9	5.7	6.4
	1/64	1.5	1.8	2.5	2.8	3.0	3.5	4.0	4.5
	1/128	1.1	1.2	1.8	1.9	2.1	2.5	2.8	3.2

## ● FP TTL AUTO

ISO100, m

ZOOM (mm)	FOUR THIRDS	8	10	12	14	17	25	35	42
	With 135	16	20	24	28	35	50	70	85
Shutter speed	1/125	8.5	9.9	14.1	15.6	17.0	19.8	22.6	25.5
	1/160	7.5	8.8	12.5	13.8	15.0	17.5	20.0	22.5
	1/200	6.7	7.8	11.2	12.3	13.4	15.7	17.9	20.1
	1/250	6.0	7.0	10.0	11.0	12.0	14.0	16.0	18.0
	1/320	5.3	6.2	8.8	9.7	10.6	12.4	14.1	15.9
	1/400	4.7	5.5	7.9	8.7	9.5	11.1	12.6	14.2
	1/500	4.2	4.9	7.1	7.8	8.5	9.9	11.3	12.7
	1/640	3.8	4.4	6.3	6.9	7.5	8.8	10.0	11.3
	1/800	3.4	3.9	5.6	6.1	6.7	7.8	8.9	10.1
	1/1000	3.0	3.5	5.0	5.5	6.0	7.0	8.0	9.0
	1/1250	2.7	3.1	4.5	4.9	5.4	6.3	7.2	8.0
	1/1600	2.4	2.8	4.0	4.3	4.7	5.5	6.3	7.1
	1/2000	2.1	2.5	3.5	3.9	4.2	4.9	5.7	6.4
	1/2500	1.9	2.2	3.2	3.5	3.8	4.4	5.1	5.7
	1/3200	1.7	2.0	2.8	3.1	3.4	3.9	4.5	5.0
	1/4000	1.5	1.8	2.5	2.8	3.0	3.5	4.0	4.5
1/5000	1.3	1.6	2.2	2.5	2.7	3.1	3.6	4.0	
1/6400	1.2	1.4	2.0	2.2	2.4	2.8	3.2	3.6	
1/8000	1.1	1.2	1.8	1.9	2.1	2.5	2.8	3.2	

## ● FP MANUAL

The following guide number figures have a 1/1 flash intensity ratio.

ISO100, m

ZOOM (mm)	FOUR THIRDS	8	10	12	14	17	25	35	42
	With 135	16	20	24	28	35	50	70	85
Shutter speed	1/125	8.5	9.9	14.1	15.6	17.0	19.8	22.6	25.5
	1/160	7.5	8.8	12.5	13.8	15.0	17.5	20.0	22.5
	1/200	6.7	7.8	11.2	12.3	13.4	15.7	17.9	20.1
	1/250	6.0	7.0	10.0	11.0	12.0	14.0	16.0	18.0
	1/320	5.3	6.2	8.8	9.7	10.6	12.4	14.1	15.9
	1/400	4.7	5.5	7.9	8.7	9.5	11.1	12.6	14.2
	1/500	4.2	4.9	7.1	7.8	8.5	9.9	11.3	12.7
	1/640	3.8	4.4	6.3	6.9	7.5	8.8	10.0	11.3
	1/800	3.4	3.9	5.6	6.1	6.7	7.8	8.9	10.1
	1/1000	3.0	3.5	5.0	5.5	6.0	7.0	8.0	9.0
	1/1250	2.7	3.1	4.5	4.9	5.4	6.3	7.2	8.0
	1/1600	2.4	2.8	4.0	4.3	4.7	5.5	6.3	7.1
	1/2000	2.1	2.5	3.5	3.9	4.2	4.9	5.7	6.4
	1/2500	1.9	2.2	3.2	3.5	3.8	4.4	5.1	5.7
	1/3200	1.7	2.0	2.8	3.1	3.4	3.9	4.5	5.0
	1/4000	1.5	1.8	2.5	2.8	3.0	3.5	4.0	4.5
	1/5000	1.3	1.6	2.2	2.5	2.7	3.1	3.6	4.0
1/6400	1.2	1.4	2.0	2.2	2.4	2.8	3.2	3.6	
1/8000	1.1	1.2	1.8	1.9	2.1	2.5	2.8	3.2	

The guide numbers for flash intensity ratios other than 1/1 in the FP MANUAL mode can be calculated with the following formula.

$$\text{Guide number} = \text{Guide number at 1/1} \times \text{Flash intensity ratio coefficient}$$

Flash intensity ratios and their coefficients

<b>Flash intensity ratio</b>	1/1	1/2	1/4	1/8	1/16
<b>Coefficient</b>	1.0	0.71	0.5	0.35	0.25

# Light control range in AUTO mode

## Usable ISO sensitivity/aperture value (F) combinations for light control in AUTO mode

AUTO light control range (m)

		ISO sensitivity						Firing angle (mm)								
								Upper row: FOUR THIRDS				Lower row: 135				
		3200	1600	800	400	200	100	50	8 (W panel)	10 (W panel)	12	14	17	25	35	42
Aperture value		F8	F5.6	F4	F2.8	F2	F1.4	0.8 - 8.6	0.9 - 10.0	1.3 - 14.3	1.4 - 15.7	1.5 - 17.1	1.8 - 20.0	2.0 - 22.9	2.3 - 25.7	
		F11	F8	F5.6	F4	F2.8	F2	F1.4	0.6 - 6.0	0.6 - 7.0	0.9 - 10.0	1.0 - 11.0	1.1 - 12.0	1.3 - 14.0	1.4 - 16.0	1.6 - 18.0
		F16	F11	F8	F5.6	F4	F2.8	F2	0.5 - 4.3	0.5 - 5.0	0.6 - 7.1	0.7 - 7.9	0.8 - 8.6	0.9 - 10.0	1.0 - 11.4	1.1 - 12.9
		F22	F16	F11	F8	F5.6	F4	F2.8	0.5 - 3.0	0.5 - 3.5	0.5 - 5.0	0.5 - 5.5	0.5 - 6.0	0.6 - 7.0	0.7 - 8.0	0.8 - 9.0
		F32	F22	F16	F11	F8	F5.6	F4	0.5 - 2.1	0.5 - 2.5	0.5 - 3.6	0.5 - 3.9	0.5 - 4.3	0.5 - 5.0	0.5 - 5.7	0.6 - 6.4
			F32	F22	F16	F11	F8	F5.6	0.5 - 1.5	0.5 - 1.8	0.5 - 2.5	0.5 - 2.8	0.5 - 3.0	0.5 - 3.5	0.5 - 4.0	0.5 - 4.5
				F32	F22	F16	F11	F8	0.5 - 1.1	0.5 - 1.3	0.5 - 1.8	0.5 - 2.0	0.5 - 2.2	0.5 - 2.5	0.5 - 2.9	0.5 - 3.3
					F32	F22	F16	F11	0.5 - 0.8	0.5 - 0.9	0.5 - 1.3	0.5 - 1.4	0.5 - 1.5	0.5 - 1.8	0.5 - 2.0	0.5 - 2.3
						F32	F22	F16	0.5 - 0.5	0.5 - 0.6	0.5 - 0.9	0.5 - 1.0	0.5 - 1.1	0.5 - 1.3	0.5 - 1.5	0.5 - 1.6

The right part of the table shows light control ranges when using a camera without communication capability. The figures given are for reference only.

When you use a camera equipped with the communication function, the light metering range for the lens in use is displayed on the control panel. This range may be different from the figures in this table.

# Continuous firing

 **For your safety,  
be sure to observe the following.**

Continuous firings make the light-emitting section hot and may result in its deterioration, malfunction or deformation. Therefore, continuous firing should be limited to the counts shown in the following table. Always leave the electronic flash unused for at least 10 minutes after continuous firing up to the limit count.



## **Limit counts of continuous firings**

Flash intensity	Flash interval	Limit count
FULL; 1/1	6 sec.	10
1/2	3 sec.	20
1/4	1 sec.	40
1/8 - 1/128	0.5 sec. or less	80

# Safety precautions (Be sure to read and observe the following)



This instruction manual uses a variety of common symbols and icons to assist you in proper handling and usage of this product and to warn you of potential hazards to yourself and others as well as to property. These symbols and their significance are described below.



Symbols for prohibiting action	Symbol instructing action
 Prohibited	 Mandatory
 Disassembly prohibited	

- This electronic flash has been designed exclusively for use with Olympus digital cameras. Do not connect the electronic flash to a camera not manufactured by Olympus, as this may result in a malfunction or damage to the camera and/or flash.

## DANGER

- The electronic flash incorporates high-voltage circuitry. Never attempt to disassemble or modify it, as this may result in electric shock and/or injury. 
- Do not use the electronic flash in a place where it may be exposed to flammable or explosive gas. Otherwise, fire ignition or explosion may result. 
- To prevent a traffic accident, do not direct the flash towards the driver of a car. 

 **WARNING**

■ Do not fire the flash or AF illuminator light immediately in front of a person's eyes (particularly an infant). Exposure to the light from the flash at a very short range may cause irreparable injury to the eyes. Be especially careful to avoid using the electronic flash at a distance of less than 1 meter from an infant.



■ Do not leave the electronic flash and batteries within reach of children.

- If a child swallows a battery or small accessory, see a doctor immediately.
- If the flash is emitted near a child, their eyes may be injured irreparably.
- Moving parts of the electronic flash could injure a child.



■ Avoid the following actions to prevent fire or injury due to battery fluid leak, overheating, fire ignition or bursting.

- Do not use batteries that are not specified for use with this electronic flash.
- Do not throw the battery in a fire, expose it to heat, short-circuit it, or disassemble it.
- Do not mix old and new batteries, or batteries of different types or brands.
- Do not attempt to recharge non-rechargeable batteries such as alkaline batteries.
- Do not load batteries with the +/- polarity reversed.



■ Do not store the electronic flash in a place exposed to excessive dust or moisture. Otherwise, fire or electric shock may result.



■ Do not use the flash when it is covered by a flammable object such as a handkerchief.  
Do not touch the light-emitting area after use. It will be very hot and could burn you.



■ If the electronic flash is dropped in water or any fluid gets inside, immediately remove the batteries. Contact your dealer or consult your Olympus Authorized Service Station.  
Continued use could result in fire or electric shock.



■ Do not expose the electric flash to dripping or splashing.



■ Do not expose the battery to excessive heat such as sunshine, fire or the like.



 **CAUTION**

■ If you notice any abnormalities such as leakage, discoloration, deformation, overheating, or odor, stop using this device. Continued use could result in fire, overheating or explosion. Remove the batteries carefully to avoid burning yourself and to prevent exposure to gas or dangerous fluids that may be released. Contact your dealer or consult your Olympus Authorized Service Station.



■ Always remove the batteries when you don't expect to use the electronic flash for a long period. Otherwise, heat generation or fluid leak from the batteries may result in fire, injury and/or contamination of the surroundings.



■ Do not use a leaking battery. Doing so could result in fire or electric shock.



■ Do not handle the electronic flash with wet hands. Doing so could result in electric shock.



■ Do not leave the electronic flash in a place where it may be exposed to high temperatures. Otherwise, deterioration of parts or fire may result.



■ Do not take out the batteries immediately after using the electronic flash continuously for a long period. Otherwise, the hot batteries may cause burns.



■ Do not deform the battery compartment or allow any foreign objects to get inside.



## BATTERY PRECAUTIONS

■ Use only the specified batteries.



■ Be sure to observe the following points. Otherwise, battery fluid leak, overheating, fire ignition and/or bursting may result.



- Do not mix old and new batteries, recharged and discharged batteries, batteries of different capacities, or batteries of different types or brands.
- Do not attempt to recharge non-rechargeable batteries such as alkaline batteries.
- Do not load or use the batteries with the +/– polarity reversed. If the batteries do not fit smoothly in the battery compartment, do not force them.
- Never use a battery if its outer coating (insulation) has been partially or entirely peeled off. Otherwise, leakage, overheating or explosion may result.
- Some brand-new batteries may also have their outer coating (insulation) peeled off completely or partially. Never use these batteries.

■ Do not use the following kinds of batteries.

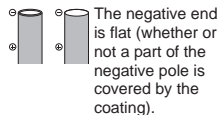
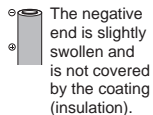
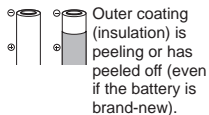

■ If battery fluid gets on your skin or clothes, it may irritate your skin. Immediately rinse your skin or clothes with clean water.



■ If battery fluid comes in contact with your eyes, blindness may result. Rinse your eyes with clean water without rubbing them and see a doctor immediately.



■ Do not apply a strong shock to a battery or throw it.



■ Do not immerse batteries in water or expose to moisture including rain, seawater and animal urine.



■ Do not throw a battery in fire or heat it.



## Caution for usage environment

- To protect the high-precision technology contained in this product, never leave the flash in the places listed below, no matter if in use or storage:
  - Places where temperatures and/or humidity are high or go through extreme changes. Direct sunlight, beaches, locked cars, or near other heat sources (stove, radiator, etc.) or humidifiers.
  - In sandy or dusty environments.
  - Near flammable items or explosives.
  - In wet places, such as bathrooms or in the rain.
  - In places prone to strong vibrations.
- Never drop the flash or subject it to severe shocks or vibrations.
- When the electronic flash has not been used for a long period, mold or moss may form. This can cause a malfunction. To prevent this, it is recommended to check the operations before using the electronic flash after a long period of storage.
- Do not touch electric contacts on the flash.

### Battery Handling Precautions

- If the +/– terminals of a battery are stained with sweat or oil smudges, contact failure may result. Clean the terminals well with a dry cloth before using the batteries.
- All rechargeable batteries must be recharged using the specified battery charger, simultaneously and completely. Be sure to read the battery and battery charger instruction manual.
- In general, battery performance will be temporarily reduced as the ambient temperature drops. When using batteries in a cold place, keep them warm by keeping the electronic flash in cold protection gear or clothing.
- When traveling, it is a good idea to carry spare batteries with you. In some countries, it may be difficult to obtain certain batteries.
- When disposing of a rechargeable battery, insulate the +/– terminals with pieces of tape and be sure to follow local regulations.

## **For customers in USA**

### FCC Notice

This device complies with part 15 of the FCC rules. Operation is subject to the following two conditions: (1) This device may not cause harmful interference, and (2) this device must accept any interference received, including interference that may cause undesired operation. Any unauthorized changes or modifications to this equipment would void the user's authority to operate.

## **For customers in CANADA**

This Class B digital apparatus complies with Canadian ICES-003.

## **For customers in Europe**



“CE” mark indicates that this product complies with the European requirements for safety, health, environment and customer protection. “CE” mark cameras are intended for sales in Europe.



This symbol [crossed-out wheeled bin WEEE Annex IV] indicates separate collection of waste electrical and electronic equipment in the EU countries.

Please do not throw the equipment into the domestic refuse.



Please use the return and collection systems available in your country for the disposal of this product.

## **Trademarks**

All brand names and product names mentioned in this manual are the trademarks or registered trademarks of their respective owners.

# Specifications

Model number	: FS-FL36R
Type	: External electronic flash for digital still camera
Guide number	: Automatic switching 36: When in 42 mm (85 mm with the 135 type) 20: When in 12 mm (24 mm with the 135 type) 12/14 switching (when the wide panel is used)
Firing angle	: Automatic switching At 12 mm: Up/down 61°, Left/right 78° (equivalent to image angle of 12 mm lens)* At 42 mm: Up/down 21°, Left/right 28° (equivalent to image angle of 42 mm lens)* At 8 mm using the wide panel: Up/down 83°, Left/right 101° (equivalent to image angle of 8 mm lens)* * ZOOM values are the FOUR THIRDS camera values.
Flash emission period	: Approx. 1/20000 to 1/500 sec. (variable according to the flash intensity, except in Super FP flash)
Flash emission count (at full activation)	: Approx. 140 times (using AA (R6) alkaline batteries) Approx. 320 times (using lithium battery packs) (Variable depending on shooting conditions)
Recharge time (from full activation to CHARGE lamp lighting)	: Approx. 7.5 seconds (using AA (R6) alkaline batteries) Approx. 6.5 seconds (using lithium battery packs)
Flash modes	: TTL AUTO, AUTO, MANUAL, FP TTL AUTO, FP MANUAL, RC, SL AUTO, SL MANUAL
Bounce angles	: Up: 0 to 90°, down: 7° Right: 0 to 90°, left: 0 to 180°
Auto power off	: Interlocks with the auto power off operation of a camera with communication capability
AF illuminator	: Automatic firing at low intensity, possible only when a camera with communication capability is connected. Standard effective distances: 1 to 5 m (3.3 to 16.4 ft.) (Variable depending on the camera and lens in use.)

RC function	: Available when used together with cameras compatible with the Olympus wireless RC flash system. Effective distance : Up to approx. 10 m (32.9 ft.)
Power supply	: AA (R6) alkaline batteries, AA (R6) NiMH batteries, AA (R6) lithium batteries, AA (R6) oxyride batteries, AA (R6) NiCd batteries × 2 or CR-V3 lithium battery pack (Olympus LB-01) × 1
Dimensions	: 67 (W) × 108 (H) × 95 (D) mm (2.6 × 4.3 × 3.7 in.) (excluding protrusions)
Weight	: 260 g (9.2 oz.) (excluding batteries)
Operating environment	: Temperature: 0 to 40°C (32 to 104°F) Humidity: No more than 80% (without condensation)

Specifications are subject to change without any notice or obligation on the part of the manufacturer.

# OLYMPUS®

<http://www.olympus.com/>

## OLYMPUS IMAGING CORP.

Shinjuku Monolith, 3-1 Nishi-Shinjuku 2-chome, Shinjuku-ku, Tokyo, Japan

## OLYMPUS IMAGING AMERICA INC.

3500 Corporate Parkway, P.O. Box 610, Center Valley, PA 18034-0610, USA Tel. 484-896-5000

### Technical Support (USA)

24/7 online automated help: <http://www.olympusamerica.com/DSLR>

Phone customer support: Tel. 1-800-260-1625 (Toll-free)

Our phone customer support is available from 8 am to 10 pm (Monday to Friday) ET

E-Mail: [e-slrpro@olympus.com](mailto:e-slrpro@olympus.com)

## OLYMPUS IMAGING EUROPA GMBH

Premises: Wendenstrasse 14-18, 20097 Hamburg, Germany

Tel: +49 40-23 77 3-0 / Fax: +49 40-23 07 61

Goods delivery: Bredowstrasse 20, 22113 Hamburg, Germany

Letters: Postfach 10 49 08, 20034 Hamburg, Germany

### European Technical Customer Support:

Please visit our homepage <http://www.olympus-europa.com>

or call our TOLL FREE NUMBER\* : **00800 - 67 10 83 00**

for Austria, Belgium, Denmark, Finland, France, Germany, Italy, Luxemburg, Netherlands,  
Norway, Portugal, Spain, Sweden, Switzerland, United Kingdom

\* Please note some (mobile) phone services providers do not permit access or request an additional prefix to +800 numbers.

For all European Countries not listed and in case that you can't get connected

to the above mentioned number, please make use of the following

CHARGED NUMBERS: **+49 180 5 - 67 10 83** or **+49 40 - 237 73 4899**

Our Technical Customer Support is available from 9 am to 6 pm MET (Monday to Friday)